



INSTRUCTION MANUAL

SIL 2 Multifunction Temperature Converter
DIN-Rail and Termination Board
Models D5072S, D5072D



Characteristics

General Description: The single and dual channel Temperature Signal Converter D5072S and D5072D accepts a low level dc signal from millivolt, thermocouple or resistance/RTD or transmitting potentiometer sensor, located in Hazardous Area, and converts, with isolation, the signal to drive a Safe Area load, suitable for applications requiring SIL 2 (according to IEC 61508:2010) in safety related systems for high risk industries. Output signal can be direct or reverse. Modbus RTU RS-485 output is available on Bus connector.

Cold junction compensation can be programmed as:

- Automatic: provided by an internal temperature sensor;
- Fixed: to a user-customizable temperature value;
- External: making use of an external RTD;
- Remote: (only D5072D) connecting compensation RTD to one of the two channels.

For D5072D module: duplicator function provides two independent outputs from one single input. Output function can be configured as: average, subtractor, low/high or redundancy selector. Modules are provided with alarm function, which is available via solid state contact output, Termination Board and Power Bus. Mounting on standard DIN-Rail, with or without Power Bus, or on customized Termination Boards, in Safe Area / Non Hazardous Location or in Zone 2 / Class I, Division 2 or Class I, Zone 2.

Functional Safety Management Certification:

G.M. International is certified by TUV to conform to IEC61508:2010 part 1 clauses 5-6 for safety related systems up to and included SIL3.



Technical Data

Supply: 24 Vdc nom (18 to 30 Vdc) reverse polarity protected, ripple within voltage limits ≤ 5 Vpp, 2 A time lag fuse internally protected.

Current consumption @ 24 V: 50 mA (D5072D), 35 mA (D5072S) with 20 mA out typical.

Power dissipation @ 24 V: 1.0 W (D5072D), 0.75 W (D5072S) with 20 mA out typical.

Isolation (Test Voltage): I.S. In/Out 2.5 KV; I.S. In/Supply 2.5 KV; I.S. In/500 V; Out/Supply 500 V; Out/Out 500 V.

Input: See section "Input specifications" for more details on Input sensors.

4-wire RTD input only on D5072S. Possibility of configuring user customized sensor (TC or RTD). Choice between °C/°F.

Integration time: from 50 ms to 500 ms depending on sensor and fast/slow integration.

Resolution: 1 μ V on mV/TC, 1 m Ω on RTD/resistance, 0.0001 % on transmitting pot.

Visualization: 0.1 °C on temp., 10 μ V on mV, 10 m Ω on resistance, 0.1 % on pot.

Input range: within sensor limits (-500 to +500 mV for mV, 0-4 k Ω for resistance).

Measuring RTD current: ≤ 0.15 mA.

2 wire RTD line resistance compensation: ≤ 50 Ω (programmable).

Thermocouple Reference Junction Compensation: programmable as automatic with internal compensator, fixed (-60 to +100 °C), external with any supported RTD, or remote using 1 channel (D5072D).

Thermocouple burnout current: ≤ 50 μ A.

Fault: enabled or disabled. Analog output can be programmed to reflect fault conditions via downscale, highscale or customized value forcing. Fault conditions are also signaled via BUS and by red LED on front panel for each channel. Fault conditions are: Sensor burnout, Sensor out of range, Output saturation, Internal fault, Cable resistance fault.

Output: Fully customizable 0/4 to 20 mA, on max. 300 Ω load source mode, current limited at 24 mA. In sink mode, external voltage generator range is V min. 3.5V at 0 Ω load and V max. 30V. If generator voltage $V_g > 10$ V, a series resistance $\geq (V_g - 10)/0.024$ Ω is needed. The maximum value of series resistance is $(V_g - 3.5)/0.024$ Ω .

Resolution: 1 μ A current output.

Transfer characteristic: linear, direct or reverse on all input sensors.

Response time: ≤ 20 ms (10 to 90 % step).

Output ripple: ≤ 20 mVrms on 250 Ω load.

Damping factor: ≤ 30 s, configurable.

Modbus Output: Modbus RTU protocol, from 4800 to 115,200 bps.

Alarm: Trip point range: within rated limits of input sensor (see input step resolution).

ON-OFF delay time: 0 to 1000 s, 100 ms step.

Hysteresis: within rated limits of input sensor.

Output: voltage free SPST photoMOS: 100 mA, 60 Vdc (≤ 1 V voltage drop).

Performance: Ref. Conditions 24 V supply, 250 Ω load, 23 ± 1 °C ambient temperature, slow integration mode, 4-wires (for D5072S) or 3-wires (for D5072D) configuration for RTD.

Input: Calibration and linearity accuracy: see section "Input Specifications".

Temperature influence: see section "Input Specifications".

Ref. Junction Compensation influence: $\leq \pm 1$ °C (internal PT1000 sensor).

Analog Output: Calibration accuracy: $\leq \pm 10$ μ A.

Linearity error: $\leq \pm 10$ μ A.

Supply voltage influence: $\leq \pm 0.02$ % of full scale for a min to max supply change.

Load influence: $\leq \pm 0.02$ % of full scale for a 0 to 100 % load resistance change.

Temperature influence: $\leq \pm 2$ μ A/°C.

Compatibility:

CE mark compliant, conforms to Directive: 2014/34/EU ATEX, 2014/30/EU EMC, 2014/35/EU LVD, 2011/65/EU RoHS.

Environmental conditions:

Operating: temperature limits -40 to +70 °C, relative humidity 95 %, up to 55 °C. **Storage:** temperature limits -45 to +80 °C.

Max altitude: 2000 m a.s.l.

Safety Description:

ATEX: II 3(1)G Ex ec [ia Ga] IIC T4 Gc, II (1)D [Ex ia Da] IIC, I (M1) [Ex ia Ma] I; **IECEx / INMETRO / NEPSI:** Ex ec [ia Ga] IIC T4 Gc, [Ex ia Da] IIC, [Ex ia Ma] I, **UL:** NI / I / 2 / ABCD / T4, AIS / I, II, III / 1 / ABCDEFG, AEx nA [ia Ga] IIC T4 Gc; **C-UL:** NI / I / 2 / ABCD / T4, AIS / I, II, III / 1 / ABCDEFG, Ex nA [ia Ga] IIC T4 Gc X, **FM:** NI-AIS / I / 2 / ABCD / T4, AIS / I,II,III / 1 / ABCDEFG, I / 2 / AEx nA [ia] / IIC / T4; **FMC:** NI-AIS / I / 2 / ABCD / T4, AIS / I,II,III / 1 / ABCDEFG, I / 2 / Ex nA [ia] / IIC / T4

EAC-EX: 2Ex nA [ia Ga] IIC T4 Gc X, [Ex ia Da] IIC, [Ex ia Ma] I.

UKR TR n. 898: 2ExnAiaIIC T4 X, Exial X

associated apparatus and non-sparking electrical equipment.

D5072S: Uo/Voc = 7.2 V, Io/Isc = 23 mA, Po/Po = 40 mW,

Ui/Vmax = 12.8 V, Ci = 0 nF, Li = 0 nH at terminals 7-8-9-10.

D5072D: Uo/Voc = 7.2 V, Io/Isc = 16 mA, Po/Po = 27 mW,

Ui/Vmax = 12.8 V, Ci = 0 nF, Li = 0 nH at terminals 7-8-9, 10-11-12.

Um = 250 Vrms or Vdc, -40 °C \leq Ta \leq 70 °C.

Approvals:

BVS 12 ATEX E 053 X conforms to EN60079-0, EN60079-7, EN60079-11. IECEx BVS 12.0050X conforms to IEC60079-0, IEC60079-7, IEC60079-11.

INMETRO DNV 13.0110 X conforms to ABNT NBR IEC60079-0, ABNT NBR IEC60079-11, ABNT NBR IEC60079-15, ABNT NBR IEC60079-26.

UL & C-UL E222308 conforms to UL913, UL 60079-0, UL60079-11, UL60079-15, UL121201 for UL

and CSA-E60079-0, CSA-E60079-11, CSA-E60079-15 and CSA-C22.2 No. 213 for C-UL.

FM 3046304 and FMC 3046304C conforms to Class 3600, 3610, 3611, 3810, ANSI/ISA-60079-0, ANSI/ISA-60079-11, ANSI/ISA-60079-15,

C22.2 No.142, C22.2 No.157, C22.2 No.213, C22.2 No. 60079-0, C22.2 No. 60079-11, C22.2 No. 60079-15.

C-IT.MH62.B.04182 conforms to GOST R IEC 60079-0, GOST R IEC 60079-11, GOST R IEC 60079-15.

CLJ 16.0036 X conforms to DCTV 7113, GOCT 22782.5-78, DCTV IEC 60079-15.

GYJ14.1406X conforms to GB3836.1, GB3836.4, GB3836.8, GB3836.20.

TC21131 for TIIS approval (only for D5072D).

TUV Certificate No. C-IS-722160171, SIL 2 conforms to IEC61508:2010 Ed.2.

TUV Certificate No. C-IS-236198-09, SIL 3 Functional Safety Certificate conforms to IEC61508:2010 Ed.2, for Management of Functional Safety.

DNV Type Approval Certificate No.A-13625 and KR No.MIL20769-EL002 Certificates for maritime applications.

Mounting: EN/IEC60715 TH 35 DIN-Rail, with or without Power Bus or on customized Termination Board.

Weight: about 135 g D5072D, 130 g D5072S.

Connection: by polarized plug-in disconnect screw terminal blocks to accommodate terminations up to 2.5 mm².

Location: installation in Safe Area/Non Hazardous Locations or Zone 2, Group IIC T4 or Class I, Division 2, Group A,B,C,D, T4 or Class I, Zone 2, Group IIC, T4.

Protection class: IP 20.

Dimensions: Width 12.5 mm, Depth 123 mm, Height 120 mm.

Programming

The module is fully programmable. Operating parameters can be changed from PC via PPC5092 adapter connected to USB serial line and SWC5090 software.

Measured values and diagnostic alarms can be read on both serial configuration or Modbus output line.

SWC5090 software also allows the Monitoring and Recording of values. For details please see SWC5090 manual ISM0154.

Ordering Information

Model:	D5072	
1 channel		S
2 channels		D

Power Bus and DIN-Rail accessories:
 Connector JDFT049
 Terminal block male MOR017

Cover and fix MCHP196
 Terminal block female MOR022

Front Panel and Features

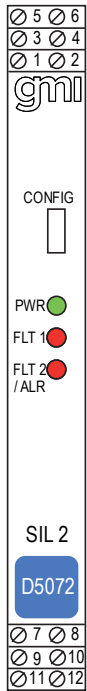

- SIL 2 according to IEC 61508:2010 (Route 2H) with Tproof = 10 / 20 years ($\leq 10\%$ / $> 10\%$ of total SIF), for analog current source/sink output.
- SIL 2 according to IEC 61508:2010 (Route 2H) with Tproof = 9 / 20 years ($\leq 10\%$ / $> 10\%$ of total SIF), for alarm output.
- SC 3: Systematic Capability SIL 3.
- Input from Zone 0 (Zone 20) / Division 1, installation in Zone 2 / Division 2.
- mV, thermocouple, 2 or 3 or 4 wire resistance/RTD or transmitting potentiometer Input Signal.
- 2-wire RTD line resistance compensation.
- Internal Reference Junction Compensation.
- Fastest integration time: 50 ms
- Fully customizable Output range from 0 to 24 mA Output Signal linear or reverse (typical 0/4-20 mA).
- Output duplication possible for D5072D.
- Modbus RTU RS-485 Output.
- Independent multiple Fault detection.
- Programmable alarm available on solid state contact output or Termination Board connector.
- High Accuracy, μ P controlled A/D converter.
- Three port isolation, Input/Output/Supply.
- EMC Compatibility to EN61000-6-2, EN61000-6-4, EN61326-1, EN61326-3-1 for safety system.
- Fully programmable operating parameters.
- ATEX, IECEx, UL & C-UL, FM, FMC, INMETRO, EAC-EX, UKR TR n. 898, NEPSI, TIIS, TÜV Certifications.
- Type Approval Certificate DNV and KR for maritime applications.
- High Density, two channels per unit.
- Simplified installation using standard DIN-Rail and plug-in terminal blocks, with or without Power Bus, or customized Termination Boards.
- 250 Vrms or Vdc (Um) max. voltage allowed to the instruments associated with the barrier.
- Data logging and monitoring via software.

Terminal block connections

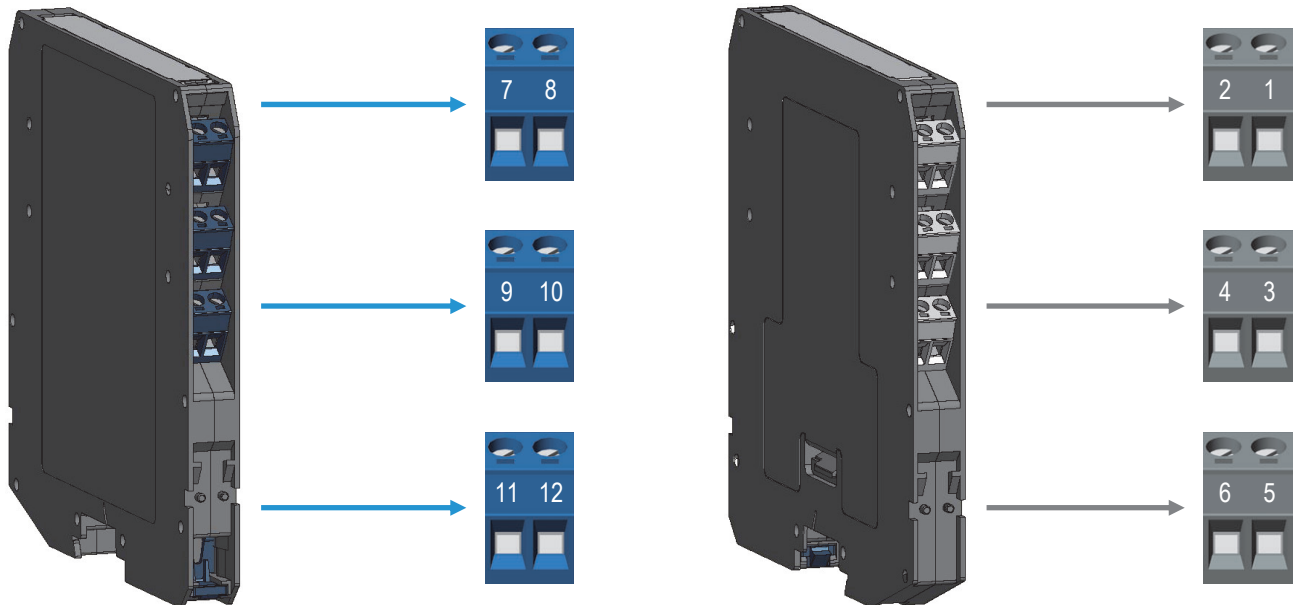

HAZARDOUS AREA

7	<u>D5072S</u> : +Input for thermocouple TC or for 3, 4 wire RTD or potentiometer <u>D5072D</u> : +Input Ch1 for thermocouple TC or for 3 wire RTD or potentiometer
8	<u>D5072S</u> : -Input for thermocouple TC or for 2, 3, 4 wire RTD or potentiometer <u>D5072D</u> : -Input Ch1 for thermocouple TC or for 2, 3 wire RTD or potentiometer
9	<u>D5072S</u> : Input for 2, 3, 4 wire RTD or potentiometer <u>D5072D</u> : Input Ch1 for 2, 3 wire RTD or potentiometer
10	<u>D5072S</u> : Input for 4 wire RTD <u>D5072D</u> : Input Ch2 for 2, 3 wire RTD or potentiometer
11	<u>D5072D</u> : +Input Ch2 for thermocouple TC or for 3 wire RTD or potentiometer
12	<u>D5072D</u> : -Input Ch2 for thermocouple TC or for 2, 3 wire RTD or potentiometer

SAFE AREA

1	<u>D5072S, D5072D (Ch1)</u> : +Output Ch1 (source current mode) or -Output Ch1 (sink current mode)
2	<u>D5072S, D5072D (Ch1)</u> : -Output Ch1 (source current mode) or +Output Ch1 (sink current mode)
3	<u>D5072S (Alarm), D5072D (Current/Alarm)</u> : +Output Ch2 (source current) or -Output Ch2 (sink current) or +Output (Alarm/Fault)
4	<u>D5072S (Alarm), D5072D (Current/Alarm)</u> : -Output Ch2 (source current) or +Output Ch2 (sink current) or -Output (Alarm/Fault)
5	+Power Supply 24 Vdc
6	-Power Supply 24 Vdc

Parameters Table

In the system safety analysis, always check the Hazardous Area/Hazardous Locations devices to conform with the related system documentation, if the device is Intrinsically Safe check its suitability for the Hazardous Area/Hazardous Locations and group encountered and that its maximum allowable voltage, current, power (U_i/V_{max} , I_i/I_{max} , P_i/P_i) are not exceeded by the safety parameters (U_o/V_{oc} , I_o/I_{sc} , P_o/P_o) of the D5072 series Associated Apparatus connected to it. Also consider the maximum operating temperature of the field device, check that added connecting cable and field device capacitance and inductance do not exceed the limits (C_o/C_a , L_o/L_a , L_o/R_o) given in the Associated Apparatus parameters for the effective group. See parameters indicated in the table below:

	D5072 Terminals	D5072 Associated Apparatus Parameters	Must be	Hazardous Area/ Hazardous Locations Device Parameters
D5072S	Ch1 7 - 8 - 9 - 10	$U_o / V_{oc} = 7.2 V$	\leq	U_i / V_{max}
D5072D	Ch1 7 - 8 - 9 Ch2 10 - 11 - 12			
D5072S	Ch1 7 - 8 - 9 - 10	$I_o / I_{sc} = 23 mA$	\leq	I_i / I_{max}
D5072D	Ch1 7 - 8 - 9 Ch2 10 - 11 - 12	$I_o / I_{sc} = 16 mA$		
D5072S	Ch1 7 - 8 - 9 - 10	$P_o / P_o = 40 mW$	\leq	P_i / P_i
D5072D	Ch1 7 - 8 - 9 Ch2 10 - 11 - 12	$P_o / P_o = 27 mW$		
	D5072 Terminals	D5072 Associated Apparatus Parameters Cenelec (US)	Must be	Hazardous Area/ Hazardous Locations Device + Cable Parameters
D5072S	Ch1 7 - 8 - 9 - 10	$C_o / C_a = 13.5 \mu F$ $C_o / C_a = 240 \mu F$ $C_o / C_a = 1000 \mu F$ $C_o / C_a = 1000 \mu F$ $C_o / C_a = 240 \mu F$	\geq	$C_i / C_i \text{ device} + C \text{ cable}$
D5072D	Ch1 7 - 8 - 9 Ch2 10 - 11 - 12	IIC (A, B) IIB (C) IIA (D) I IIIC (E, F, G)		
D5072S	Ch1 7 - 8 - 9 - 10	$L_o / L_a = 67 mH$ $L_o / L_a = 268 mH$ $L_o / L_a = 537 mH$ $L_o / L_a = 882 mH$ $L_o / L_a = 268 mH$	\geq	$L_i / L_i \text{ device} + L \text{ cable}$
D5072D	Ch1 7 - 8 - 9 Ch2 10 - 11 - 12	IIC (A, B) IIB (C) IIA (D) I IIIC (E, F, G)		
D5072S	Ch1 7 - 8 - 9 - 10	$L_o / R_o = 875 \mu H/\Omega$ $L_o / R_o = 3500 \mu H/\Omega$ $L_o / R_o = 7000 \mu H/\Omega$ $L_o / R_o = 11480 \mu H/\Omega$ $L_o / R_o = 3500 \mu H/\Omega$	\geq	$L_i / R_i \text{ device and}$ $L \text{ cable} / R \text{ cable}$
D5072D	Ch1 7 - 8 - 9 Ch2 10 - 11 - 12	IIC (A, B) IIB (C) IIA (D) I IIIC (E, F, G)		

When used with separately powered intrinsically safe devices, check that maximum allowable voltage, current (U_i/V_{max} , I_i/I_{max}) of the D5072 Associated Apparatus are not exceeded by the safety parameters (U_o/V_{oc} , I_o/I_{sc}) of the Intrinsically Safe device, indicated in the table below:

	D5072 Terminals	D5072 Associated Apparatus Parameters	Must be	Hazardous Area/ Hazardous Locations Device Parameters
D5072S	Ch1 7-8-9-10	$U_i / V_{max} = 12.8 \text{ V}$	\geq	U_o / V_{oc}
D5072D	Ch1 7-8-9 Ch2 10-11-12			
D5072S	Ch1 7-8-9-10	$C_i = 0 \text{ nF}$, $L_i = 0 \text{ nH}$		
D5072D	Ch1 7-8-9 Ch2 10-11-12			

For installations in which both the C_i and L_i of the Intrinsically Safe apparatus exceed 1 % of the C_o and L_o parameters of the Associated Apparatus (excluding the cable), then 50 % of C_o and L_o parameters are applicable and shall not be exceeded (50 % of the C_o and L_o become the limits which must include the cable such that C_i device + C cable \leq 50 % of C_o and L_i device + L cable \leq 50 % of L_o). The reduced capacitance of the external circuit (including cable) shall not be greater than 1 μF for Groups I, IIA, IIB and 600 nF for Group IIC.

If the cable parameters are unknown, the following value may be used: Capacitance 200 pF per meter (60 pF per foot), Inductance 1 μH per meter (0.20 μH per foot).

Function Diagram

HAZARDOUS AREA ZONE 0 (ZONE 20) GROUP IIC,
HAZARDOUS LOCATIONS CLASS I, DIVISION 1, GROUPS A, B, C, D,
CLASS II, DIVISION 1, GROUPS E, F, G, CLASS III, DIVISION 1,
CLASS I, ZONE 0, GROUP IIC

SAFE AREA, ZONE 2 GROUP IIC T4,
NON HAZARDOUS LOCATIONS, CLASS I, DIVISION 2,
GROUPS A, B, C, D T-Code T4, CLASS I, ZONE 2, GROUP IIC T4

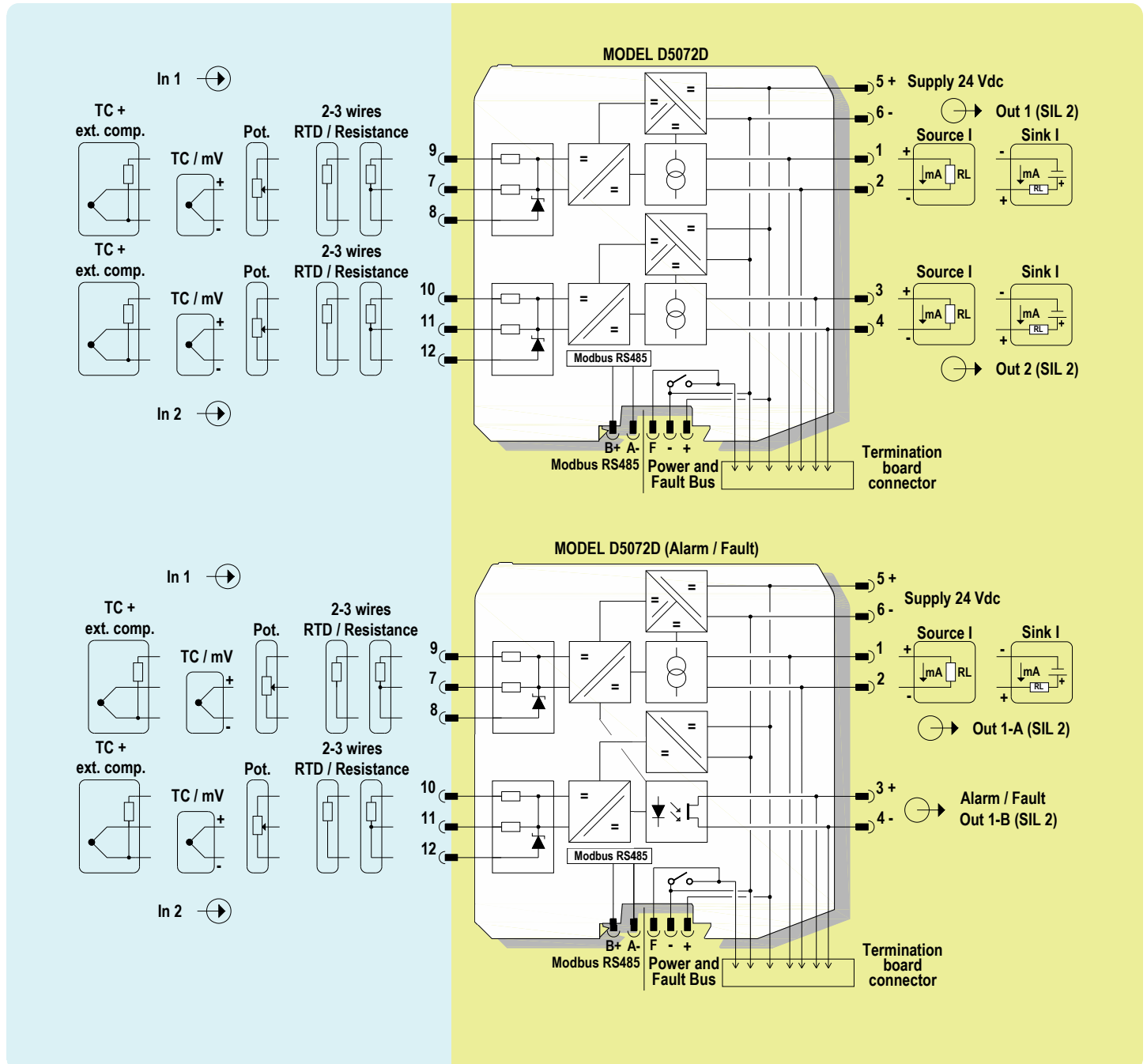

Function Diagram

HAZARDOUS AREA ZONE 0 (ZONE 20) GROUP IIC,
HAZARDOUS LOCATIONS CLASS I, DIVISION 1, GROUPS A, B, C, D,
CLASS II, DIVISION 1, GROUPS E, F, G, CLASS III, DIVISION 1,
CLASS I, ZONE 0, GROUP IIC

SAFE AREA, ZONE 2 GROUP IIC T4,
NON HAZARDOUS LOCATIONS, CLASS I, DIVISION 2,
GROUPS A, B, C, D T-Code T4, CLASS I, ZONE 2, GROUP IIC T4

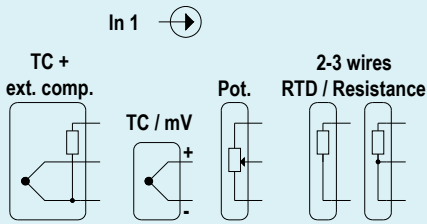

MODEL D5072D (Duplicator)

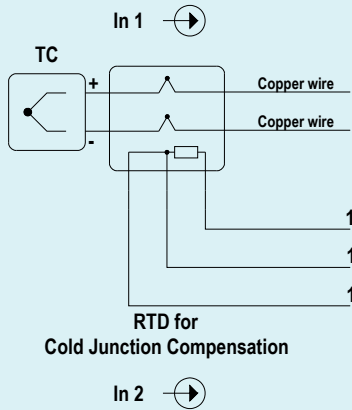
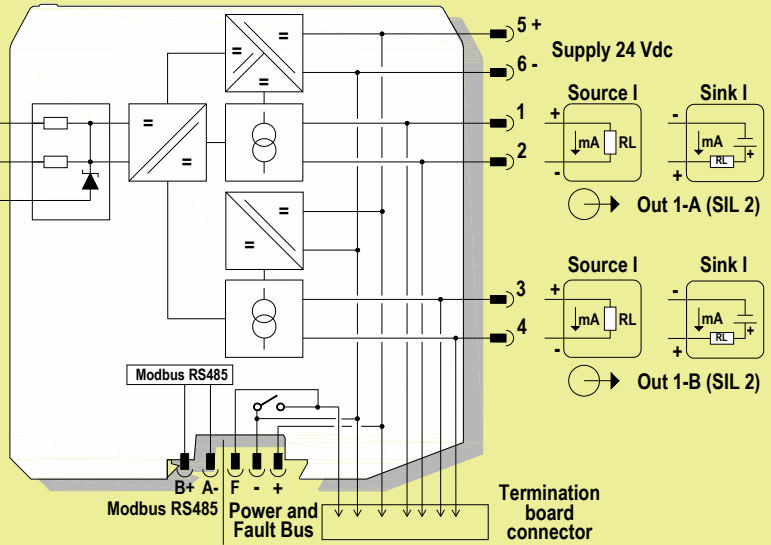

MODEL D5072D (with optional remote CJC)

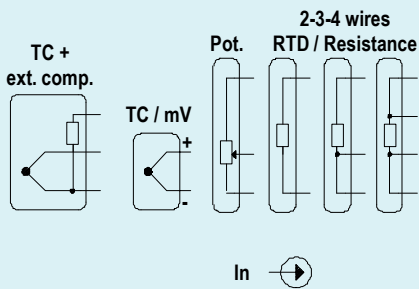
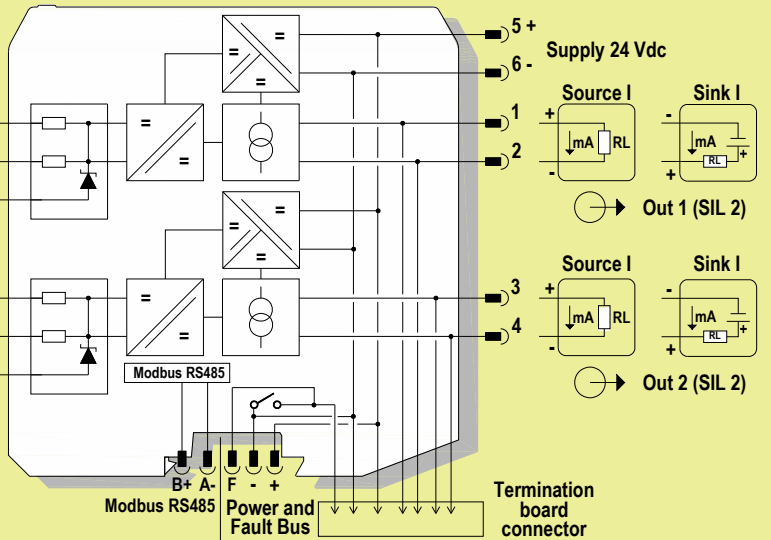

MODEL D5072S

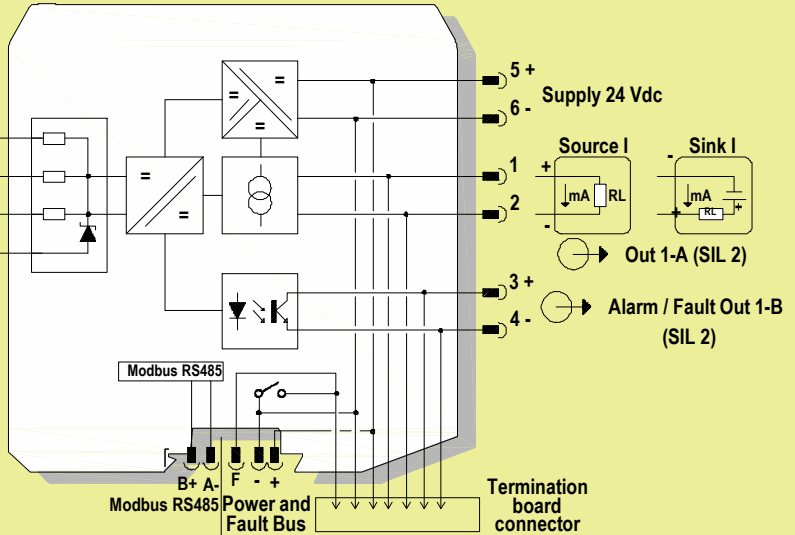

Warning

D5072 series are isolated Intrinsically Safe Associated Apparatus installed into standard EN/IEC60715 TH 35 DIN-Rail located in Safe Area or Zone 2, Group IIC, Temperature T4 or Class I, Division 2, Group A, B, C, D, T4 Hazardous Area within the specified operating temperature limits Tamb -40 to +70 °C, and connected to equipment with a maximum limit for power supply Um of 250 Vrms or Vdc.

Not to be connected to control equipment that uses or generates more than 250 Vrms or Vdc with respect to earth ground.

D5072 series must be installed, operated and maintained only by qualified personnel, in accordance to the relevant national/international installation standards (e.g. EN/IEC60079-14 Electrical apparatus for explosive gas atmospheres - Part 14: Electrical installations in hazardous areas (other than mines)), following the established installation rules, particular care shall be given to segregation and clear identification of I.S. conductors from non I.S. ones.

De-energize power source (turn off power supply voltage) before plug or unplug the terminal blocks when installed in Hazardous Area or unless area is known to be nonhazardous.

Warning: substitution of components may impair Intrinsic Safety and suitability for Zone 2.

Explosion Hazard: to prevent ignition of flammable or combustible atmospheres, disconnect power before servicing or unless area is known to be nonhazardous.

Failure to properly installation or use of the equipment may risk to damage the unit or severe personal injury.

The unit cannot be repaired by the end user and must be returned to the manufacturer or his authorized representative. Any unauthorized modification must be avoided.

Operation

Each input channel of Temperature Signal Converter D5072 accepts a low level dc signal from millivolt, thermocouple or 2-3-4 wire RTD temperature or transmitting potentiometer sensor, located in Hazardous Area, and converts, with isolation, the signal to a 4-20 mA floating output current to drive a Safe Area load.

Presence of supply power is displayed by a "POWER ON" green signaling LED; integrity of field sensor and connecting line can be monitored by a configurable burnout circuit which, if enabled, can drive output signal to upscale or downscale limit. Burnout condition is signaled by red front panel LED for each channel.

D5072D module has double input and output channel, and can also be programmed to interface a single input and obtain dual output channel (duplicator) or configurable output channel (outputs can repeat the corresponding inputs or be proportional to the sum or difference of the two input process variables or with low/high selector function).

Installation

D5072 series are Temperature Signal Converter housed in a plastic enclosure suitable for installation on EN/IEC60715 TH 35 DIN-Rail, with or without Power Bus or on customized Termination Board.

D5072 series can be mounted with any orientation over the entire ambient temperature range.

Electrical connection are accommodated by polarized plug-in removable screw terminal blocks which can be plugged in/out into a powered unit without suffering or causing any damage **(for Zone 2 installations check the area to be nonhazardous before servicing)**. Connect only one individual conductor per each clamping point, use conductors up to 2.5 mm² (13 AWG) and a torque value of 0.5-0.6 Nm. Use only cables that are suitable for a temperature of at least 85°C. The wiring cables have to be proportionate in base to the current and the length of the cable.

In case of installation in zone 2, the connecting cables of non-intrinsically safe circuits must be safely routed in a cable duct or similar. The distance between the pluggable connection terminal and the cable duct should not exceed 500 mm cable length.

On the section "Function Diagram" and enclosure side a block diagram identifies all connections.

Intrinsically Safe conductors must be identified and segregated from non I.S. and wired in accordance to the relevant national/international installation standards (e.g. EN/IEC60079-14 Electrical apparatus for explosive gas atmospheres - Part 14: Electrical installations in hazardous areas (other than mines)), make sure that conductors are well isolated from each other and do not produce any unintentional connection.

Connect alarm transistors checking the load rating to be within the maximum rating (100 mA at 60 Vdc (≤ 1 V voltage drop)).

The enclosure provides, according to EN60529, an IP20 minimum degree of protection (or similar to NEMA Standard 250 type 1). The equipment shall only be used in an area of at least pollution degree 2, as defined in IEC 60664-1. When installed in EU Zone 2, the unit shall be installed in an enclosure that provides a minimum ingress protection of IP54 in accordance with IEC 60079-0. When installed in a Class I, Zone 2 Hazardous Location, the unit shall be mounted in a supplemental AEx or Ex enclosure that provides a degree of protection not less than IP54 in accordance with UL/CSA 60079-0. When installed in a Class I, Division 2 Hazardous Location, the unit shall be mounted in a supplemental enclosure that provides a degree of protection not less than IP54. The enclosure must have a door or cover accessible only by the use of a tool. The end user is responsible to ensure that the operating temperature of the module is not exceeded in the end use application.

Units must be protected against dirt, dust, extreme mechanical (e.g. vibration, impact and shock) and thermal stress, and casual contacts. If enclosure needs to be cleaned use only a cloth lightly moistened by a mixture of detergent in water.

Electrostatic Hazard: to avoid electrostatic hazard, the enclosure of D5072 must be cleaned only with a damp or antistatic cloth.

Any penetration of cleaning liquid must be avoided to prevent damage to the unit. Any unauthorized modification must be avoided.

D5072 series must be connected to SELV or SELV-E supplies.

All circuits connected to D5072 series must comply with the overvoltage category II (or better) according to EN/IEC60664-1.

Start-up

Before powering the unit check that all wires are properly connected, particularly supply conductors and their polarity, input and output wires, also check that Intrinsically Safe conductors and cable trays are segregated (no direct contacts with other non I.S. conductors) and identified either by color coding, preferably blue, or by marking.

Check conductors for exposed wires that could touch each other causing dangerous unwanted shorts.

Check that the module has been correctly configured through SWC5090 software. For details please see SWC5090 manual ISM0154.

Turn on power, the "power on" green LED must be lit, output on each channel must be in accordance with the corresponding input signal value and input/output chosen transfer function.

If possible change the sensor condition and check the corresponding Safe Area output.

Input specifications:

Input	Type	Alpha [°C ⁻¹]	Nominal resistance [Ω]	Standards	Min Span [°C (°F)]	Accuracy [°C (°F)]	Accuracy Range [°C (°F)]	Maximum Range [°C (°F)]	Temperature Influence per °C typical [°C (°F)]	
RTD	Platinum	0.003851	50	IEC 60751 GOST 6651 JIS C 1604	40 (72)	±0.5 (±0.9)	-200 to 850 (-328 to 1562)	-200 to 850 (-328 to 1562)	≤ ±0.015 (≤ ±0.027)	
			100		20 (36)	±0.2 (±0.4)				
			200		10 (18)	±0.1 (±0.2)				
			300							
			400							
			500							
		1000	0.003916	100	JIS C 1604	20 (36)	±0.2 (±0.4)	-200 to 630 (-328 to 1166)	-200 to 630 (-328 to 1166)	≤ ±0.015 (≤ ±0.027)
		0.003926		100	---	20 (36)	±0.2 (±0.4)	-200 to 630 (-328 to 1166)	-200 to 630 (-328 to 1166)	≤ ±0.015 (≤ ±0.027)
		0.003911	46	100	GOST 6651	40 (72)	±0.5 (±0.9)	-200 to 650 (-328 to 1202)	-200 to 650 (-328 to 1202)	≤ ±0.015 (≤ ±0.027)
						50	20 (36)			
	100									
	200					10 (18)	±0.1 (±0.2)			
	300									
	400									
	500									
Nickel	0.006178	100	DIN 43760	20 (36)	±0.2 (±0.4)	-60 to 180 (-76 to 356)	-60 to 180 (-76 to 356)	≤ ±0.015 (≤ ±0.027)		
	0.006720	120	---		±0.2 (±0.4)	-80 to 260 (-112 to 500)	-80 to 260 (-112 to 500)	≤ ±0.015 (≤ ±0.027)		
Copper	0.004260	53	GOST 6651	40 (72)	±0.4 (±0.7)	-50 to 180 (-58 to 356)	-50 to 180 (-58 to 356)	≤ ±0.015 (≤ ±0.027)		
		50	GOST 6651	40 (72)	±0.4 (±0.7)	-50 to 200	-50 to 200	≤ ±0.015		
	100			20 (36)	±0.2 (±0.4)	-58 to 392)	-58 to 392)	(≤ ±0.027)		
0.004274	9.035	---	100 (180)	±1.7 (±3.1)	-200 to 260 (-328 to 500)	-200 to 260 (-328 to 500)	≤ ±0.050 (≤ ±0.090)			
TC	A1	---	GOST 8.585	150 (270)	±0.7 (±1.3)	0 to 2500 (32 to 4532)	0 to 2500 (32 to 4532)	≤ ±0.090 (≤ ±0.162)		
	A2	---	GOST 8.585	100 (180)	±0.5 (±0.9)	0 to 1800 (32 to 3272)	0 to 1800 (32 to 3272)	≤ ±0.050 (≤ ±0.090)		
	A3	---	GOST 8.585	100 (180)	±0.5 (±0.9)	0 to 1800 (32 to 3272)	0 to 1800 (32 to 3272)	≤ ±0.050 (≤ ±0.090)		
	B	---	IEC 60584 GOST 8.585 ASTM E230	200 (360)	±1.1 (±2.0)	450 to 1820 (842 to 3308)	0 to 1820 (32 to 3308)	≤ ±0.060 (≤ ±0.108)		
	C	---	ASTM E230 ASTM E988	100 (180)	±0.6 (±1.1)	0 to 2315 (32 to 4199)	0 to 2315 (32 to 4199)	≤ ±0.080 (≤ ±0.144)		
	D	---	ASTM E988	100 (180)	±0.6 (±1.1)	0 to 2315 (32 to 4199)	0 to 2315 (32 to 4199)	≤ ±0.080 (≤ ±0.144)		
	E	---	IEC 60584 GOST 8.585 ASTM E230	50 (90)	±0.2 (±0.4)	-150 to 1000 (-238 to 1832)	-270 to 1000 (-454 to 1832)	≤ ±0.050 (≤ ±0.090)		
	J	---	IEC 60584 GOST 8.585 ASTM E230	50 (90)	±0.2 (±0.4)	-150 to 1200 (-238 to 2192)	-210 to 1200 (-346 to 2192)	≤ ±0.050 (≤ ±0.090)		
	K	---	IEC 60584 GOST 8.585 ASTM E230	50 (90)	±0.3 (±0.5)	-150 to 1372 (-238 to 2502)	-270 to 1372 (-454 to 2502)	≤ ±0.050 (≤ ±0.090)		
	L (type "L" DIN)	---	DIN 43710	50 (90)	±0.2 (±0.4)	-200 to 900 (-328 to 1652)	-200 to 900 (-328 to 1652)	≤ ±0.050 (≤ ±0.090)		
	LR (type "L" GOST)	---	GOST 8.585	50 (90)	±0.3 (±0.5)	-200 to 800 (-328 to 1472)	-200 to 800 (-328 to 1472)	≤ ±0.050 (≤ ±0.090)		
	N	---	IEC 60584 GOST 8.585 ASTM E230	50 (90)	±0.4 (±0.7)	-150 to 1300 (-238 to 2372)	-270 to 1300 (-454 to 2372)	≤ ±0.060 (≤ ±0.108)		
	R	---	IEC 60584 GOST 8.585 ASTM E230	150 (270)	±0.8 (±1.4)	50 to 1768 (122 to 3214)	-50 to 1768 (-58 to 3214)	≤ ±0.060 (≤ ±0.108)		
	S	---	IEC 60584 GOST 8.585 ASTM E230	150 (270)	±0.8 (±1.4)	50 to 1768 (122 to 3214)	-50 to 1768 (-58 to 3214)	≤ ±0.060 (≤ ±0.108)		
	T	---	IEC 60584 GOST 8.585 ASTM E230	50 (90)	±0.2 (±0.4)	-100 to 400 (-148 to 752)	-270 to 400 (-454 to 752)	≤ ±0.020 (≤ ±0.036)		
U	---	DIN 43710	50 (90)	±0.4 (±0.7)	-200 to 600 (-328 to 1112)	-200 to 600 (-328 to 1112)	≤ ±0.040 (≤ ±0.072)			
Ohm	Type		Nominal resistance [Ω]		Min Span [Ω]	Accuracy [Ω]	Accuracy Range [Ω]	Maximum Range [Ω]	Temperature Influence per °C typical [Ω]	
	Resistance standard		0 to 1000		5	±0.2	0 to 1000	0 to 1000	≤ ±0.02	
	Resistance extended		0 to 4000		20	±0.4	0 to 4000	0 to 4000	≤ ±0.20	
	Potentiometer		100 to 10000		1%	±0.1%	0 to 100%	0 to 100%	≤ ±0.02%	
mV	Type				Min Span [mV]	Accuracy [μV]	Accuracy Range [mV]	Maximum Range [mV]	Temperature Influence per °C typical [μV]	
	DC standard				1	±10	-50 to 80	-100 to 100	≤ ±3	
	DC extended				10	±100	-500 to 500	-500 to 500	≤ ±20	

Notes:

RTD/resistance accuracy shown in 4-wires (for D5072S) or 3-wires (for D5072D) configuration, in slow acquisition mode, after calibration.

TC/mV Accuracy shown in slow acquisition mode, after calibration.

Supported Modbus functions:

Code	Name	Notes
03	read holding registers	reads a stream of words from memory
04	read input registers	reads a stream of words from memory
08	diagnostics: subcode 0	returns query data
06	write single register	writes a word in memory
16	write multiple registers	writes a stream of words in memory

Supported Modbus parameters:

The unit can communicate via Modbus RTU RS-485 protocol. Below is a list of all available registers.

Each Modbus parameter is described by one 16-bit word.

- 'Addr.' is the address of the parameter.

- 'Description' explains the function of the parameter.

- 'Rights' identifies the operation that can be executed by the user:

RO (Read Only);

WO (Write Only);

RW (Read and Write).

- 'Type' indicates the kind of the variable:

SINT8 / UINT8: signed / unsigned 8 bits integer;

SINT16 / UINT16: signed / unsigned 16 bits integer;

SINT32 / UINT32: signed / unsigned 32 bits integer;

FLOAT: floating point single precision real;

DOUBLE: floating point double precision real;

the suffix '[n]' indicates an array of n elements of the corresponding type.

Addr.	Description	Rights	Type
IDENTIFICATION			
0	GM International code	RO	UINT16
1	Software revision	RO	UINT16
2	Product code	RO	UINT16
3	Option code	RO	UINT16
4	Hardware revision	RO	UINT16
COMMAND EXECUTION			
100	Command (*1)	WO	UINT16
GENERAL CONFIGURATION			
202	Fault on bus mask (*2)	RW	UINT32
MODBUS COMMUNICATION			
300	Modbus address	RW	UINT16
301	Modbus baud-rate (*3)	RW	UINT16
302	Modbus format (*4)	RW	UINT16
GENERAL DEBUG			
400	Time stamp [100ms]	RO	UINT32
404	Cumulative faults (*2)	RO	UINT32
TAG			
700	Tag 1	RW	UINT8[16]
708	Tag 2	RW	UINT8[16]
OUTPUT CONFIGURATION			
800	Input to analog out 1 function (*5)	RW	UINT16
801	Input to analog out 2 function (*5)	RW	UINT16
ALARM CONFIGURATION			
803	Input to alarm 2 function (*5)	RW	UINT16
INPUT CONFIGURATION			
804	Integration speed (*6)	RW	UINT16
900	Ch1: sensor family (*7)	RW	UINT16
901	Ch1: sensor connection (*8)	RW	UINT16
902	Ch1: sensor type (*9)	RW	UINT16
903	Ch1: sensor burnout configuration (*10)	RW	UINT16
904	Ch1: cold junction compensation (*11)	RW	UINT16
905	Ch1: cold junction external type (*9)	RW	UINT16
1000	Ch2: sensor family (*7)	RW	UINT16
1001	Ch2: sensor connection (*8)	RW	UINT16
1002	Ch2: sensor type (*9)	RW	UINT16
1003	Ch2: sensor burnout configuration (*10)	RW	UINT16
1004	Ch2: cold junction compensation (*11)	RW	UINT16
1005	Ch2: cold junction external type (*9)	RW	UINT16
1100	Ch1: cold junction fixed value [0.1°C]	RW	SINT32
1102	Ch1: 2-wire rtd correction [mOhm]	RW	SINT32
1104	Ch1: rtd multiplier	RW	FLOAT
1200	Ch2: cold junction fixed value [0.1°C]	RW	SINT32
1202	Ch2: 2-wire rtd correction [mOhm]	RW	SINT32
1204	Ch2: rtd multiplier	RW	FLOAT
MEASURE			
1500	Ch1: sensor value (volt, res, ratio) [uV, mOhm, ppm]	RO	SINT32
1502	Ch1: cold junction resistance value [mOhm]	RO	SINT32
1504	Ch1: sensor temperature [0.1°C]	RO	SINT32
1506	Ch1: cold junction temperature [0.1°C]	RO	SINT32
1600	Ch2: sensor value (volt, res, ratio) [uV, mOhm, ppm]	RO	SINT32

Addr.	Description	Rights	Type
1602	Ch2: cold junction resistance value [mOhm]	RO	SINT32
1604	Ch2: sensor temperature [0.1°C]	RO	SINT32
1606	Ch2: cold junction temperature [0.1°C]	RO	SINT32
OUTPUT CONFIGURATION			
1900	Ch1: output downscale [100nA]	RW	SINT32
1902	Ch1: output upscale [100nA]	RW	SINT32
1904	Ch1: output underrange [100nA]	RW	SINT32
1906	Ch1: output overrange [100nA]	RW	SINT32
1908	Ch1: output in case of fault [100nA]	RW	SINT32
1910	Ch1: output fault mask (*2)	RW	UINT32
1916	Ch1: output damping factor [s]	RW	UINT32
1918	Ch1: input downscale [uV, mOhm, ppm]	RW	SINT32
1920	Ch1: input upscale [uV, mOhm, ppm]	RW	SINT32
2000	Ch2: output downscale [100nA]	RW	SINT32
2002	Ch2: output upscale [100nA]	RW	SINT32
2004	Ch2: output underrange [100nA]	RW	SINT32
2006	Ch2: output overrange [100nA]	RW	SINT32
2008	Ch2: output in case of fault [100nA]	RW	SINT32
2010	Ch2: output fault mask (*2)	RW	UINT32
2016	Ch2: output damping factor [s]	RW	UINT32
2018	Ch2: input downscale [uV, mOhm, ppm]	RW	SINT32
2020	Ch2: input upscale [uV, mOhm, ppm]	RW	SINT32
OUTPUT DEBUG			
2302	Ch1: output virtual value [100nA]	RO	SINT32
2402	Ch2: output virtual value [100nA]	RO	SINT32
ALARM CONFIGURATION			
2600	Ch2: alarm configuration (*13)	RW	UINT32
2604	Ch2: alarm start lock (*14)	RW	UINT32
2606	Ch2: contact position in case of alarm (*15)	RW	UINT32
2608	Ch2: alarm fault configuration (*16)	RW	UINT32
2610	Ch2: alarm fault mask (*2)	RW	UINT32
2612	Ch2: delay to alarm issue [ms]	RW	UINT32
2614	Ch2: delay to alarm removal [ms]	RW	UINT32
2616	Ch2: alarm low threshold [uV, mOhm, ppm]	RW	SINT32
2618	Ch2: alarm low threshold hysteresis [uV, mOhm, ppm]	RW	SINT32
2620	Ch2: alarm high threshold [uV, mOhm, ppm]	RW	SINT32
2622	Ch2: alarm high threshold hysteresis [uV, mOhm, ppm]	RW	SINT32
ALARM DEBUG			
2806	Ch2: alarm virtual state (*17)	RO	UINT32
OUTPUT CONFIGURATION			
2900	Ch1: output drive (*18)	RW	UINT16
3000	Ch2: output drive (*18)	RW	UINT16
INPUT CONFIGURATION			
3100	Callendar-van dusen coeff. A [1/°C]	RW	FLOAT
3102	Callendar-van dusen coeff. B [1/°C ²]	RW	FLOAT
3104	Callendar-van dusen coeff. C [1/°C ⁴]	RW	FLOAT
3106	Callendar-van dusen res. at 0°C [mOhm]	RW	UINT32
3108	Table minimum temperature [0.1°C]	RW	SINT32
3110	Table maximum temperature [0.1°C]	RW	SINT32
3200	Sensor family (*7)	RW	UINT32
3202	Table minimum temperature [0.1°C]	RW	SINT32
3204	Table maximum temperature [0.1°C]	RW	SINT32
3206	Table temperature step [0.1°C]	RW	UINT32
3210	Custom sensor table [uV, mOhm]	RW	SINT32[100]

Modbus parameters details:

*1 Command List

Bit pos.	Value	Description
0..3	10	full eeprom write

*2 Fault Mask

Bit pos.	Value	Description
0..0	0	no internal/hardware fault
	1	internal/hardware fault
1..1	0	no configuration fault
	1	configuration fault
2..2	0	no input 1 open/burnout
	1	input 1 open/burnout
3..3	0	no input 2 open/burnout
	1	input 2 open/burnout
4..4	0	no input 1 cold junction
	1	input 1 cold junction
5..5	0	no input 2 cold junction
	1	input 2 cold junction
6..6	0	no input 1 cable resistance
	1	input 1 cable resistance
7..7	0	no input 2 cable resistance
	1	input 2 cable resistance
8..8	0	no input 1 out of spec
	1	input 1 out of spec
9..9	0	no input 2 out of spec
	1	input 2 out of spec
10..10	0	no analog out 1 saturation
	1	analog out 1 saturation
11..11	0	no analog out 2 saturation
	1	analog out 2 saturation

*3 Modbus Baudrate

Bit pos.	Value	Description
0..2	0	baud rate = 4800 bit/s
	1	baud rate = 9600 bit/s
	2	baud rate = 19200 bit/s
	3	baud rate = 38400 bit/s
	4	baud rate = 57600 bit/s
	5	baud rate = 115200 bit/s

*4 Modbus Format

Bit pos.	Value	Description
0..1	0	parity none
	1	parity even
	2	parity odd
2..2	0	termination resistance off
	1	termination resistance on
3..3	0	32-bit endianness little
	1	32-bit endianness big

*5 Input-to-Output Assignment

Bit pos.	Value	Description
0..3	0	input1 temp
	1	input2 temp
	2	mean input temp = (input1 temp + input2 temp)/2
	3	input1 temp - input2 temp
	4	input2 temp - input1 temp
	5	max(input1 temp, input2 temp)
	6	min(input1 temp, input2 temp)
	7	input redundancy = mean input temperature or temperature of the healthy sensor
	8	electrical measure 1
	9	electrical measure 2
	10	electrical measure + cj voltage 1 (compensated sensor 1)
	11	electrical measure + cj voltage 2 (compensated sensor 2)

*6 Integration Speed

Bit pos.	Value	Description
0..0	0	slow
	1	fast

*7 Sensor Family

Bit pos.	Value	Description
0..2	0	thermocouple
	1	rtd
	2	voltage
	3	resistance
	4	potentiometer

*8 Sensor Connection

Bit pos.	Value	Description
0..2	0	volt/tc 2 wires
	1	tc + external compensation
	2	res/rtd 2 wires
	3	res/rtd 3 wires
	4	res/rtd 4 wires
	5	potentiometer 3 wires

*9 Sensor Type

Bit pos.	Value	Description
0..5	0	thermocouple A1
	1	thermocouple A2

2	thermocouple A3
3	thermocouple B
4	thermocouple C
5	thermocouple D
6	thermocouple E
7	thermocouple J
8	thermocouple K
9	thermocouple L
10	thermocouple LR
11	thermocouple N
12	thermocouple R
13	thermocouple S
14	thermocouple T
15	thermocouple U
16	Pt50 rtd (a=0.003851)
17	Pt100 rtd (a=0.003851)
18	Pt200 rtd (a=0.003851)
19	Pt300 rtd (a=0.003851)
20	Pt400 rtd (a=0.003851)
21	Pt500 rtd (a=0.003851)
22	Pt1000 rtd (a=0.003851)
23	Pt46 rtd (a=0.003911)
24	Pt50 rtd (a=0.003911)
25	Pt100 rtd (a=0.003911)
26	Pt200 rtd (a=0.003911)
27	Pt300 rtd (a=0.003911)
28	Pt400 rtd (a=0.003911)
29	Pt500 rtd (a=0.003911)
30	Pt100 rtd (a=0.003916)
31	Pt100 rtd (a=0.003926)
32	Cu53 rtd (a=0.004260)
33	Cu9.035 rtd (a=0.004274)
34	Cu50 rtd (a=0.004280)
35	Cu100 rtd (a=0.004280)
36	Ni100 rtd (a=0.006178)
37	Ni120 rtd (a=0.006720)
38	voltage standard
39	voltage extended
40	resistance standard
41	resistance extended
42	potentiometer
43	callendar Van Dusen
44	custom sensor

*10 Input Burnout Configuration

Bit pos.	Value	Description
0..0	0	input burnout active
	1	input burnout off

*11 Cold Junction Compensation

Bit pos.	Value	Description
0..1	0	internal
	1	fixed
	2	other sensor
	3	external

*12 Cold Junction Force Command

Bit pos.	Value	Description
0..0	0	cold junction measured
	1	cold junction fixed

*13 Alarm Configuration

Bit pos.	Value	Description
0..2	0	no alarm
	1	alarm low
	2	alarm high
	3	alarm window
	4	fault repeater

*14 Alarm Lock

Bit pos.	Value	Description
0..0	0	no alarm lock
	1	alarm lock activated

*15 Contact Position In Case Of Alarm

Bit pos.	Value	Description
0..0	0	open
	1	closed

*16 Alarm Fault Configuration

Bit pos.	Value	Description
0..1	0	ignore fault
	1	lock alarm state before fault
	2	alarm on in case of fault
	3	alarm off in case of fault

*17 Alarm Virtual State

Bit pos.	Value	Description
0..0	0	alarm off
	1	alarm on

*18 Output Drive

Bit pos.	Value	Description
0..0	0	output sink
	1	output source