

BA337E and BA338E
One input
intrinsically safe
pulse input
rate totalisers
Issue 6

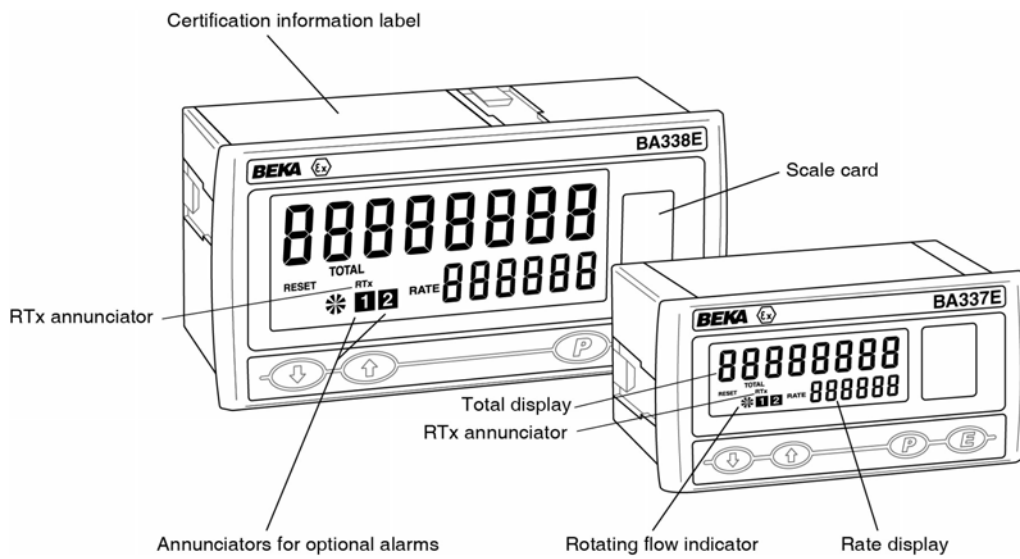

CONTENTS

1. Description

2. Operation

- 2.1 Initialisation
- 2.2 Controls
- 2.3 Displays
 - 2.3.1 Display over-range

3. Intrinsic Safety Certification

- 3.1 ATEX gas certification
- 3.2 Zones, gas groups & T rating
- 3.3 Special conditions for safe use
- 3.4 Power supply
- 3.5 Pulse input
 - 3.5.1 Flowmeters that don't require energising.
 - 3.5.2 Flowmeters that require energising
- 3.6 Remote reset terminals
- 3.7 Certification label information

4. System Design for Hazardous Areas

- 4.1 Use with Zener barriers
 - 4.1.1 Power supply
 - 4.1.2 Pulse input
 - 4.1.3 Switch contact input
 - 4.1.4 Open collector input
 - 4.1.5 2-wire proximity detector input
 - 4.1.6 Magnetic pick-off input
 - 4.1.7 Voltage pulse input
 - 4.1.8 Remote reset
- 4.2 Use with galvanic isolators
 - 4.2.1 Power supply
 - 4.2.2 Pulse input
 - 4.2.3 Switch contact input
 - 4.2.4 Open collector input
 - 4.2.5 2-wire proximity detector input
 - 4.2.6 Magnetic pick-off input
 - 4.2.7 Voltage pulse input
 - 4.2.8 Remote reset

5. Installation

- 5.1 Location
- 5.2 EMC
- 5.3 Installation procedure
- 5.4 Scale card

6. Configuration and Calibration

- 6.1 Configuration structure
- 6.2 Accessing configuration functions
- 6.3 Summary of configuration functions
- 6.4 Rate totaliser function: $F_{\text{un}}[t, \text{on}]$
- 6.5 Input: i, nP_{ut}
- 6.6 Input type: i, nP_{tYPE}
- 6.7 Debounce: $dE_{\text{bounce}}[t]$
- 6.8 Display update interval: $uPdRE$
- 6.9 Upper display: $d, 5P-1$
- 6.10 Lower display: $d, 5P-2$
- 6.11 Position of decimal points: dP
- 6.12 Flowmeter K-factor: $FR[t_{\text{or}}$
- 6.13 Total scale factor: $5[RL]E.t$
- 6.14 Rate scale factor: $5[RL]E.r$
- 6.15 Timebase: $t-bR5E$
- 6.16 Display filter: $F, LLEr$
- 6.17 Clip-off: $[LP] oFF$
- 6.18 Local reset: $L_{o}[[Lr]$
- 6.19 Local total reset: $[Lr] t_{\text{ot}}$
- 6.20 Local grand total reset: $[Lr] Gt_{\text{ot}}$
- 6.21 Grand total reset from configuration menu: $[Lr] Gt_{\text{ot}}$
- 6.22 Define security code: $[_{\text{od}}E$
- 6.23 Reset to factory defaults: $r5E t dEF$

7. Lineariser

- 7.1 Flowmeter specification
- 7.2 Summary of lineariser configuration functions.
- 7.3 Add a segment: Rdd
- 7.4 Remove a segment: dEL
- 7.5 Input frequency: $P_{\text{uL}}5EFrE$
- 7.6 Flowmeter K-factors: $L-FR[t_{\text{or}}$
- 7.7 Lineariser error messages

8. Configuration example

- 8.1 Configuration procedure

9. Maintenance

- 9.1 Fault finding during commissioning
- 9.2 Fault finding after commissioning
- 9.3 Servicing
- 9.4 Routine maintenance
- 9.5 Guarantee
- 9.6 Customer comments

CONTENTS CONTINUED

10. Accessories

10.1 Scale card

10.2 Tag information

10.3 Backlight

10.4 Alarms

- 10.4.1 Solid state output
- 10.4.2 Intrinsic safety
- 10.4.3 Configuration and adjustment
- 10.4.4 Alarm enable: *EnbL*
- 10.4.5 Type of alarm: *LYPE*
- 10.4.6 Setpoint adjustment: *SP lx* and *SP2x*
- 10.4.7 Alarm function: *Hi.Lo*
- 10.4.8 Alarm output status: *nonE*
- 10.4.9 Hysteresis: *H5Er*
- 10.4.10 Alarm delay: *dELR*
- 10.4.11 Alarm silence time: *S, L*
- 10.4.12 Flash display: *FL5H*
- 10.4.13 Access setpoint: *RC5P*
- 10.4.14 Adjusting alarm setpoints
from totalisation mode:

10.5 Pulse Output

- 10.5.1 Intrinsic safety
- 10.5.2 System design
- 10.5.3 Configuration
- 10.5.4 Pulse output: *PULSE oP*
- 10.5.5 Enable: *EnbL*
- 10.5.6 Pulse source: *SourceE*
- 10.5.7 Output pulse frequency: *d, U, dE*
- 10.5.8 Output pulse width: *durRE, on*
- 10.5.9 Pulse storage

10.6 4/20mA output

- 10.6.1 Intrinsic safety
- 10.6.2 System design
- 10.6.3 Configuration
- 10.6.4 4/20mA output: *4-20oP*
- 10.6.5 Enable 4/20mA output: *EnbL*
- 10.6.6 Select rate or total source: *4-20LYPE*
- 10.6.7 Display for 4mA output: *4.000*
- 10.6.8 Display for 20mA output: *20.000*

Appendix 1 IECEx certification

Appendix 2 ETL and cETL certification

1. DESCRIPTION

These intrinsically safe, one input rate totalisers are primarily intended for use with pulse output flowmeters. The instruments simultaneously display the rate of flow and the total flow in the same or different engineering units on two separate displays. They are controlled and configured via the four front panel push buttons, a user defined four digit code may be entered to prevent accidental access to the instrument's configuration menu.

The two models are electrically similar, but have different size displays and enclosures. The available factory fitted accessories also vary.

Model	Displays	Bezel size
BA337E	8 digits 9mm high 6 digits 6mm high	96 x 48mm
BA338E	8 digits 18mm high 6 digits 12mm high	144 x 72mm

This instruction manual supplements the abbreviated instruction sheet supplied with each instrument.

Both models have been certified intrinsically safe for use in gas hazardous areas by Notified Body Intertek Testing and Certification Ltd and comply with the European ATEX Directive 2014/34/EU.

For international applications both models also have IECEx certification which is described in Appendix 1.

For applications in the USA and Canada both models have ETL and cETL certification which is described in Appendix 2.

2. OPERATION

Fig 1 shows a simplified block diagram of the BA337E and BA338E Rate Totalisers. The instruments can accept pulses from most types of flowmeter transducers. When connected to a pulse output flowmeter the BA337E and BA338E will provide an accurate display of the rate of flow and the total flow in the same or different engineering units. The internal lineariser, which can have up to sixteen straight-line segments, may be calibrated to compensate for flowmeter non-linearity.

The BA337E and BA338E have a single pair of input terminals for connection to all types of transducer. When counting pulses from a transducer requiring energising, such as a switch contact, open collector or a two wire proximity detector, an external link between terminals 3 and 4 supplies power to the transducer input terminals.

Factory fitted accessories include an internally powered display backlight, dual alarms and an isolated 4/20mA output which may be configured to retransmit the rate or total display.

The larger BA338E Rate Totaliser is always supplied with an isolated pulse output which can be configured to synchronously retransmit the pulse input, or the flow total. This output is only available on the smaller BA337E Rate Totaliser as an option.

Factory fitted optional accessories for the two models are shown below:

BA337E 96 x 48mm	BA338E 144 x 72mm
Backlight	Backlight
Isolated dual alarms* or Isolated 4/20mA output* or Isolated pulse output*	Isolated dual alarms Isolated 4/20mA output

**Only one output option may be fitted to BA337E* *Isolated pulse output always fitted to BA338E*

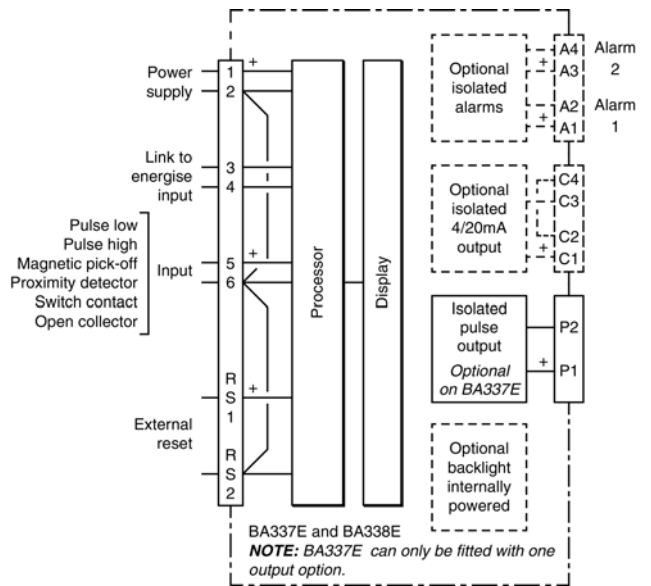

Fig 1 BA337E and BA338E block diagram

2.1 Initialisation

Each time power is applied to the Rate Totaliser initialisation is performed. After a short delay the following display sequence occurs:

All segments of the display are activated

Instrument starts functioning using the configuration information stored in permanent memory. Unless total and grand total displays have been reset to zero, new flow will be added to the existing totals.

2.2 Controls

The BA337E and BA338E are controlled and configured via four front panel push buttons. In the totalisation mode i.e. when the instrument is displaying rate and total flow the push button functions are:

Push Button Functions

- [E] + [▼]** Grand total - shows L_0 followed by least significant 8 digits of the 16 digit grand total.
- [E] + [▲]** Grand total - shows H_1 followed by the most significant 8 digits of the 16 digit grand total.
If Local Grand Total Reset [Lr] [tob] in the instrument configuration menu has been activated, operating the [E] + [▲] buttons for ten seconds will result in [Lr.no] being displayed with the no flashing. Operating the [▼] or [▲] button will change the display to [Lr.yE5], the [E] button will then reset the grand total to zero which will be confirmed by a brief display of [t] [Lrd]. See 6.20
- [▼] + [▲]** If Local Total Reset [Lr] [tob] in the instrument configuration menu has been activated, operating the [▼] + [▲] buttons for three seconds will reset the total display to zero and clear any pulses stored in the optional pulse output. The Grand Total is not reset. See 6.19
- [P] + [▼]** Shows in succession, firmware version number, instrument function [ob]RL, 5E and any output accessories that are fitted:
 - R Dual alarm outputs
 - P Pulse output
 - [4/20mA output
- [P] + [▲]** Provides direct access to the alarm setpoints when the Rate Totaliser is fitted with optional alarms and the RESP setpoints function has been enabled. See 10.4.13 and 10.4.14
- [P] + [E]** Access to configuration menu

2.3 Displays

The BA337E and BA338E have two digital displays and associated annunciators, plus a flow indicator as shown on page 1.

Total display	Shows the total flow on the upper eight digit display. May be reset to zero via front panel push buttons or by a remote reset switch.
Rate Display	Shows the flow rate on the lower six digit display.
Flow indicator	This disc in the lower left hand corner of the display 'rotates' for two seconds each time an input pulse is received. Appears to rotate continuously when input frequency exceeds 0.5Hz.
Hold annunciator	Activated when input frequency is below the clip-off threshold.
Reset annunciator	Activated while instrument is being reset via the front panel push buttons, or the external reset terminals.
Rate annunciator	Identifies rate display
Total annunciator	Identifies total display
RTx annunciator	Retransmitted pulse annunciator. Depends upon the setting of S_{outEE} in the pulse output configuration menu.
	SCALE# Annunciator activated each time pulse output open collector is on, i.e. Ron is less than $60\Omega + 3V$.
	d, rEE: Annunciator continuously activated.

2.3.1 Display over-range

Over-range of the upper eight digit display or the lower six digit display is indicated by all the digits displaying 9 and all the decimal points flashing.

3. INTRINSIC SAFETY CERTIFICATION

The BA337E and the BA338E rate totalisers have ATEX and IECEx gas certification. This section of the instruction manual describes ATEX gas certification. IECEx and other approvals are each described in separate appendixes to this manual.

3.1 ATEX gas certification

Notified Body Intertek Testing and Certification Ltd have issued the BA337E and the BA338E with an EC-Type Examination Certificate number ITS16ATEX28408X. This confirms compliance with harmonised European standards and it has been used to confirm compliance with the European ATEX Directive for Group II, Category 1G equipment. The Rate Totalisers carry the European Community mark and subject to local codes of practice may be installed in any of the European Economic Area (EEA) member countries. ATEX certificates are also acceptable for installations in Switzerland.

This section of the instruction manual describes ATEX installations in explosive gas atmospheres complying with EN60079-14 *Electrical Installation Design, Selection and Erection*. When designing systems for installation outside the UK the local Code of Practice should be consulted.

3.2 Zones, gas groups and T rating

The BA337E and BA338E Rate Totalisers have been certified Ex ia IIC T5 Ga $-40^{\circ}\text{C} \leq T_a \leq +70^{\circ}\text{C}$. When connected to a suitable system they may be installed in:

- | | |
|--------|---|
| Zone 0 | explosive gas air mixture continuously present. |
| Zone 1 | explosive gas air mixture likely to occur in normal operation. |
| Zone 2 | explosive gas air mixture not likely to occur, and if it does will only exist for a short time. |

In gases that may be used with equipment having a temperature classification of:

- Group A propane
- Group B ethylene
- Group C hydrogen

Having a temperature classification of:

- T1 450°C
- T2 300°C
- T3 200°C
- T4 135°C
- T5 100°C

At ambient temperatures between -40 and $+70^{\circ}\text{C}$.

Note: The specified operating temperature of the BA337E and BA338E is -40 to $+70^{\circ}\text{C}$. At temperatures below -20°C the instruments will continue to function, but the display digits will change more slowly and contrast will be reduced.

This allows the Rate Totalisers to be installed in all gas Zones and to be used with most common industrial gases except carbon disulphide and ethyl nitrite which have an ignition temperature of 95°C .

3.3 Special conditions for safe use

The ATEX certificate has an 'X' suffix indicating that special conditions apply to prevent an electrostatic charge developing on the outside of the instrument enclosure.

WARNING

To avoid an electrostatic charge being generated instrument enclosure should only be cleaned with a damp cloth.

3.4 Power supply

When installed in a hazardous area the BA337E and the BA338E should be powered from a certified Zener barrier, galvanic isolator or associated apparatus with an intrinsically safe voltage output.

The safety parameters of terminals 1 and 2 are:

$$\begin{aligned} U_i &= 28\text{V dc} \\ I_i &= 200\text{mA dc} \\ P_i &= 0.84\text{W} \end{aligned}$$

$$\begin{aligned} U_o &= 0 \\ I_o &= 0 \end{aligned}$$

Any certified Zener barrier, galvanic isolator or associated apparatus with output safety parameters equal to or less than these input limits may be used.

The maximum equivalent capacitance and inductance between terminals 1 and 2 is:

$$\begin{aligned} C_i &= 2\text{nF} \\ L_i &= 4\mu\text{H} \end{aligned}$$

To determine the maximum permissible cable parameters the above figures, which are small and may be ignored in some applications, should be subtracted from the maximum permitted cable parameters specified for the Zener barrier, galvanic isolator or associated apparatus powering the BA337E or BA338E Rate Totaliser.

3.5 Pulse input terminals

The BA337E and BA338E Rate Totalisers have a single pair of pulse input terminals 5 and 6 that may be configured for use with different types of flowmeter.

For flowmeters with transducers that require energising to determine their state, such as switch contacts or a 2-wire proximity detector in a turbine flowmeter, an external link between terminals 3 & 4 of the BA337E or BA338E connects an internal 7V, 6mA supply to the input. Energising is not required when the Rate Totaliser's input is connected to a voltage pulse source.

Fitting an external link between terminals 3 & 4 changes the output safety parameters of the Rate Totaliser input terminals 5 & 6 as shown in the following table. This table also shows the types of sensor requiring energising (link fitting).

Type of input	Link 3 & 4	Output safety parameters		
		Uo	Io	Po
Switch contact	Yes	10.5V	9.2mA	24mW
Proximity detector	Yes	10.5V	9.2mA	24mW
Open collector	Yes	10.5V	9.2mA	24mW
Magnetic pick-off	No	1.1V	0.5mA	0.2mW
Voltage input (low)	No	1.1V	0.5mA	0.2mW
Voltage input (high)	No	1.1V	0.5mA	0.2mW

3.5.1 Flowmeter sensors that don't require energising.

Flowmeters employing magnetic pick-offs or voltage pulse sensors do not require energising, therefore terminals 3 & 4 should not be linked. When not energised i.e. without a link, the output parameters of the pulse input terminals comply with the requirements for *simple apparatus*. For intrinsic safety purposes, sources of energy with output parameters less than 1.5V; 100mA and 25mW are considered to be *simple apparatus* (Clause 5.7 of EN60079-11), which allows their output parameters Uo, Io & Po to be ignored when assessing the safety of an intrinsically safe system, thus simplifying loop assessment and documentation.

Almost any flowmeter with a voltage pulse output may be directly connected to the BA337E or BA338E input in a hazardous area providing that:

- a. The flowmeter is a certified intrinsically safe device having output parameters equal to or less than:

$$\begin{aligned} U_o &\leq 28V \text{ dc} \\ I_o &\leq 200mA \text{ dc} \\ P_o &\leq 0.84W \end{aligned}$$

or complies with requirements for *simple apparatus*.

- b. The flowmeter and associated wiring can withstand a 500V rms insulation test to earth.
- c. The flowmeter is located in the same hazardous area as the BA337E or BA338E.

The BA337E and BA338E EC-Type Examination Certificate specifies that the equivalent capacitance and inductance of pulse input is:

$$\begin{aligned} C_i &= 2nF \\ L_i &= 4\mu H \end{aligned}$$

To determine the maximum permissible cable parameters these figures should be subtracted from the maximum permitted output parameters Lo and Co specified by the certificate for the flowmeter connected to the totaliser's pulse input terminals. The totalisers pulse input equivalent capacitance and inductance are small and unlikely to make a significant difference to the allowable cable parameters.

3.5.2 Flowmeter sensors that require energising

Flowmeters with switch contacts, proximity detector or open collector outputs require energising which is achieved by linking Rate Totaliser terminals 3 and 4 together as described in section 3.5. When energised, the output parameters of the pulse input terminals 5 and 6 are:

$$\begin{aligned} U_o &= 10.5V \text{ dc} \\ I_o &= 9.2mA \text{ dc} \\ P_o &= 24mW \end{aligned}$$

These output parameters do not comply with the requirements for *simple apparatus* and should be considered when assessing the safety of the flowmeter connected to the totaliser pulse input.

Any certified intrinsically safe flowmeter may be connected to a BA337E or BA338E energised input providing that:

- a. The flowmeter is a certified intrinsically safe device having input parameters equal to or greater than:

$$\begin{aligned} U_i &\geq 10.5V \text{ dc} \\ I_i &\geq 9.2mA \text{ dc} \\ P_i &\geq 24mW \end{aligned}$$

or complies with the requirements for *simple apparatus*.

- b. The flowmeter and associated wiring can withstand a 500V rms insulation test to earth.
- c. The flowmeter is located in the same hazardous area as the BA337E or BA338E.
- d. Minimum operating voltage of a flowmeter incorporating a proximity detector is less than 7.5V.

The BA337E and BA338E EC-Type Examination Certificate specifies that the maximum capacitance and inductance that may be safely connected to the energised pulse input terminals 5 & 6 (terminals 3 & 4 linked) is:

$$\begin{aligned} C_o &= 2.4\mu\text{F} \\ L_o &= 200\text{mH} \end{aligned}$$

This is not restrictive as the combined capacitance and inductance of most sensors and the connecting cable will be less than this.

3.6 Remote reset terminals

The BA337E and BA338E total display may be reset to zero by connecting the external reset terminals RS1 and RS2 together for more than one second. The two reset terminals have the following input and output safety parameters:

$$\begin{aligned} U_o &= 3.8\text{V dc} \\ I_o &= 1\text{mA} \\ P_o &= 1\text{mW} \end{aligned}$$

$$\begin{aligned} U_i &= 28\text{V dc} \\ I_i &= 200\text{mA dc} \\ P_i &= 0.84\text{W} \end{aligned}$$

The equivalent capacitance and inductance between them is:



$$\begin{aligned} C_i &= 0 \\ L_i &= 0 \end{aligned}$$

The maximum cable capacitance and inductance that may be safely connected between the reset terminals RS1 and RS2 is:

$$\begin{aligned} C_o &= 40\mu\text{F} \\ L_o &= 1\text{H} \end{aligned}$$

The reset terminals may be directly connected to any mechanically operated switch located within the same hazardous area as the BA337E or BA338E Rate Totaliser. The switch and associated wiring should be able to withstand a 500V rms insulation test to earth.

If the reset switch is required in the safe area a Zener barrier or intrinsically safe relay is required to transfer the contact closure into the hazardous area. Almost any intrinsically safe relay with certification permitting the contacts to be connected to equipment in the hazardous area may be used. A positive polarity Zener barrier may also be used as shown in Fig 2.

Alternatively the BA337E or BA338E may be configured so that the total display is reset to zero when the  and  push buttons are operated simultaneously for more than three seconds. See 6.19

3.7 Certification label information

The Rate Totaliser certification information label is fitted in a recess on the top outer surface of the enclosure. It shows the ATEX and IECEx certification information plus BEKA associates name, location, year of manufacture and the instrument serial number. Non European certification information may also be included.



BA337E Certification information label

4. SYSTEM DESIGN FOR HAZARDOUS AREAS

4.1 Use with Zener barriers

Zener barriers are the least expensive intrinsically safe interface between a safe and hazardous area. However they require a high integrity earth connection that may be expensive to install and they do not provide isolation. When a high integrity earth connection is not already available, it may be less expensive and complicated to use galvanic isolators for the installation of a single BA337E or BA338E.

Terminals 2, 6 and RS2 of the BA337E and BA338E Rate Totalisers are internally connected together. If any of these terminals are earthed, as shown in Figs 2 & 3, the other common terminals should only be connected to the same earth, i.e. the barrier busbar, or to circuits that have 500V insulation to earth.

Any Zener barrier may be used with the BA337E and BA338E providing it's certification is for use with apparatus in the required Zone and gas group, and it's output parameters do not exceed the input parameters of the Rate Totaliser terminals to which it is connected. Only one polarity of Zener barrier i.e. positive or negative, may be used in a Rate Totaliser system.

Fig 2 illustrates the basic circuit that is used for all BA337E and BA338E installations protected by Zener barriers. For simplicity, connections for the pulse output and optional alarms and 4/20mA output are shown separately in section 10 of this manual.

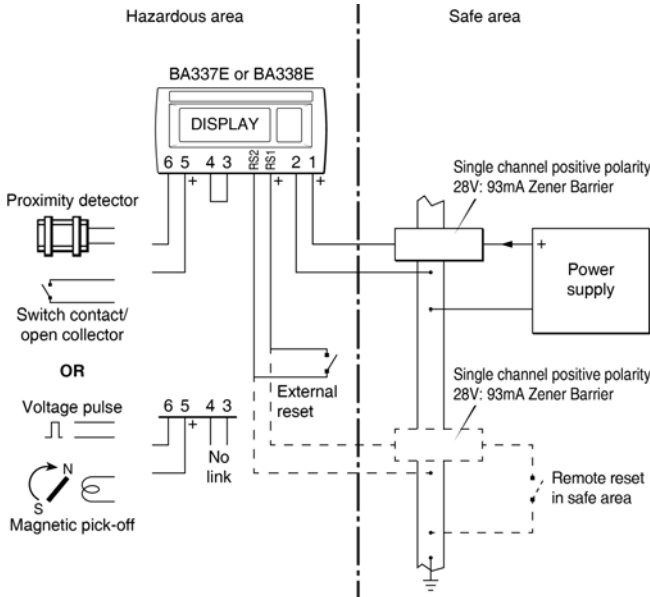

Fig 2 BA337E or BA338E used with Zener barriers

Alternatively the pulse source may be located in the safe area. Fig 3 shows how an additional Zener barrier is used to transfer the signal to the rate totaliser in the hazardous area. When more than one Zener barrier is used in a system all must have the same polarity, i.e. all positive or all negative barriers.

When designing a system it is important to remember that terminals 2, 6 and RS2 are interconnected within the BA337E and the BA338E. See Fig 1.

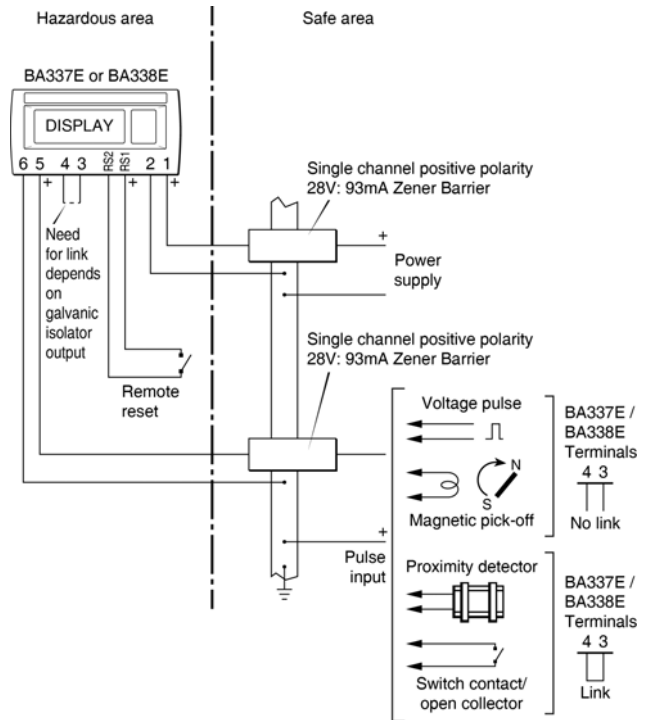

Fig 3 BA337E or BA338E used with Zener barriers pulse source in safe area.

4.1.1 Power supply

The BA337E and the BA338E Rate Totalisers require a minimum of 10V between terminal 1 & 2 and consume:

	10mA	without optional backlight
plus	6mA	when terminals 3 & 4 are linked

Any certified Zener barrier may be used to power a BA337E or BA338E Rate Totaliser providing the output safety parameters of the barrier are equal to or less than the input safety parameters of terminals 1 & 2 of the Rate Totaliser.

Although this allows a wide variety of barriers to be used, a positive polarity 28V; 93mA; 300Ω Zener barrier, which has an end-to-end resistance of about 340Ω, is an industry standard device which is frequently used. With this barrier the supply voltage in the safe area must be between 15.5V and the maximum working voltage of the Zener barrier which, depending upon manufacturer, will be approximately 26V.

Note: The optional factory fitted display backlight increase the instrument's current consumption and therefore increases the minimum safe area operating voltage, see section 10.3 for details.

4.1.2 Pulse input

As shown in Figs 2 and 3 the BA337E and the BA338E can display the rate and total flow from flowmeters with a wide variety of pulse outputs located in safe and hazardous areas.

No Zener barrier is required in series with the input if the intrinsically safe flowmeter is located within the same hazardous area as the Rate Totaliser.

The following table shows the Rate Totaliser's input switching thresholds when conditioned for use with flowmeters having different outputs, For reliable totalisation the Rate Totaliser pulse input must fall below the lower threshold and rise above the upper threshold.

Input transducer	Switching thresholds	
	Lower	Upper
Open collector	2k Ω	10k Ω
Voltage pulse low	1.0V	3.0V
Voltage pulse high	3.0V	10.0V
Magnetic pick-off	0mV	40mV peak
Proximity detector	1.2mA	2.1mA
Switch	100 Ω	1000 Ω

Flowmeters with a switch contact, proximity detector or an open collector output require energising which is achieved by linking Rate Totaliser terminals 3 and 4.

4.1.3 Switch contact input

Any flowmeter with a mechanically or magnetically activated switch contact located in the same hazardous area as the Rate Totaliser may be directly connected to pulse input terminals 5 and 6, providing the flowmeter and associated wiring can withstand a 500V rms insulation test to earth. Most magnetically activated reed relays used in turbine flowmeters comply with these requirements. The BA337E and the BA338E contain a configurable debounce circuit to prevent contact bounce being counted. See section 6.7.

4.1.4 Open collector input

Certified intrinsically safe flowmeters with an open collector output may be directly connected to input terminals 5 & 6 providing the flowmeter is located in the same hazardous area as the Rate Totaliser and the flowmeter and associated wiring can withstand a 500V rms insulation test to earth.

The BA337E and BA338E contain a configurable debounce circuit to prevent false triggering. Three levels of de-bounce protection are independently available. See section 6.7.

4.1.5 2-wire proximity detector input

Most certified intrinsically safe flowmeters incorporating a NAMUR 2-wire proximity detector may be directly connected to a BA337E or BA338E input, providing the input safety parameters of the flowmeter (proximity detector) are equal to or greater than the output safety parameters of Rate Totaliser's pulse input. i.e.

$$\begin{aligned} U_i &\geq 10.5V \text{ dc} \\ I_i &\geq 8.2mA \text{ dc} \\ P_i &\geq 24mW \end{aligned}$$

and the minimum operating voltage of the flowmeter (proximity detector) is less than 7.5V. The flowmeter must be located in the same hazardous area as the BA337E or BA338E and with the associated wiring be able to withstand a 500V rms insulation test to earth.

The Rate Totalisers contain a configurable debounce circuit to prevent false triggering. Three levels of debounce protection are independently available. See section 6.7.

4.1.6 Magnetic pick-off input

Flowmeters incorporating a magnetic pick-off to sense flow will have a low level voltage output unless the flowmeter incorporates an amplifier. $\{O, L$ in the BA337E and BA338E input configuration menu is a low level voltage pulse input intended for use with an intrinsically safe magnetic pick-off. When a Rate Totaliser is configured for $\{O, L$ and terminals 3 & 4 are not linked, the input terminals 5 & 6 comply with the requirements for *simple apparatus* allowing connection to any certified intrinsically safe magnetic sensor having output parameters equal to or less than:

$$\begin{aligned} U_o &\leq 28V \text{ dc} \\ I_o &\leq 200mA \text{ dc} \\ P_o &\leq 0.84W \end{aligned}$$

The maximum permitted cable parameters will be the magnetic pick-off's C_o and L_o specified on it's intrinsic safety certificate, less the Rate Totalisers pulse input parameters C_i and L_i which are small and can often be ignored.

The flowmeter must be located within the same hazardous area as the Rate Totaliser and with the associated wiring be able to withstand a 500V rms insulation test to earth.

The Rate Totalisers contain a configurable debounce circuit to prevent false triggering of the instrument. See section 6.7.

4.1.7 Voltage pulse input

Two voltage pulse input ranges are selectable in the BA337E and BA338E Rate Totaliser configuration menu, $U_{oLt5} L$ and $U_{oLt5} H$. When configured for either of the voltage pulse ranges and terminals 3 & 4 are not linked, the input terminals 5 & 6 comply with the requirements for *simple apparatus*. This allows the input to be connected to any certified intrinsically safe flowmeter with a voltage output located in the same hazardous area as the Rate Totaliser having output parameters equal to or less than:

$$\begin{aligned} U_o &\leq 28V \text{ dc} \\ I_o &\leq 200\text{mA dc} \\ P_o &\leq 0.84W \end{aligned}$$

The Rate Totaliser input may therefore be directly connected to most certified intrinsically safe flowmeters with a high level voltage pulse output.



The maximum permitted cable parameters will be defined by the intrinsic safety certification of the flowmeter less the Rate Totalisers input parameters C_i & L_i which are small and can often be ignored.

The Rate Totalisers contain a configurable debounce circuit to prevent false triggering of the instrument. Three levels of de-bounce protection are independently available. See section 6.7.

4.1.8 Remote reset

The Rate Totaliser's total display may be remotely reset to zero by connecting terminals RS1 and RS2 together for more than one second. Permanent interconnection inhibits totalisation. Remote resetting may be accomplished by any mechanically operated switch located in the same hazardous area as the Rate Totaliser providing the switch and the associated wiring can withstand a 500V rms insulation test to earth. No Zener barrier is required.

A BA337E or BA338E may also be remotely reset from the safe area. Any switch may be used but a Zener barrier is required to transfer the contact closure into the hazardous area which may be combined with the supply barrier so that only one package is required. A diode return barrier is not suitable for this application. Fig 2 illustrates how a BA337E or BA338E may be reset from both the safe and the hazardous area.

Note: Both Rate Totalisers may be configured to reset the total display to zero by operating the  and  push buttons simultaneously for more than two seconds in the totalising mode i.e. when the instrument is displaying flow. See 6.19

4.2 Use with Galvanic Isolators

Galvanic isolators are probably the simplest intrinsically safe interface to install as they provide isolation and do not require a high integrity earth connection.

Any galvanic isolator may be used with the BA337E and BA338E providing it's certification is for use with apparatus in the required Zone and gas group, and it's output parameters do not exceed the input parameters of the Rate Totaliser terminals to which it is connected. It must also have the correct function.

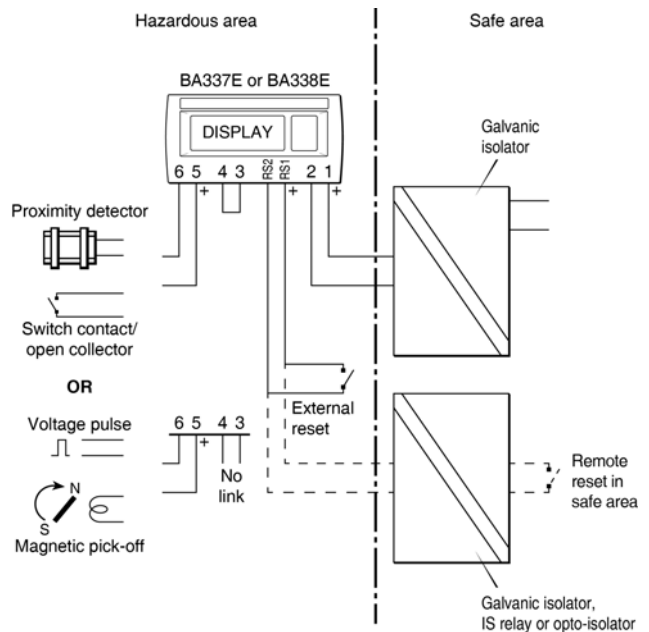

Fig 4 BA337E or BA338E used with galvanic isolators.

Fig 4 illustrates the basic circuit that is used for all BA337E and BA338E installations protected by galvanic isolators. For simplicity, connections for the pulse output and optional alarms and 4/20mA output are shown separately in section 10 of this manual.

The totaliser pulse source may be located in the safe area as shown in Fig 5. An additional galvanic isolator is used to transfer the signal to the rate totaliser in the hazardous area, although it may be difficult to find isolators for transferring some flowmeter transducer outputs.

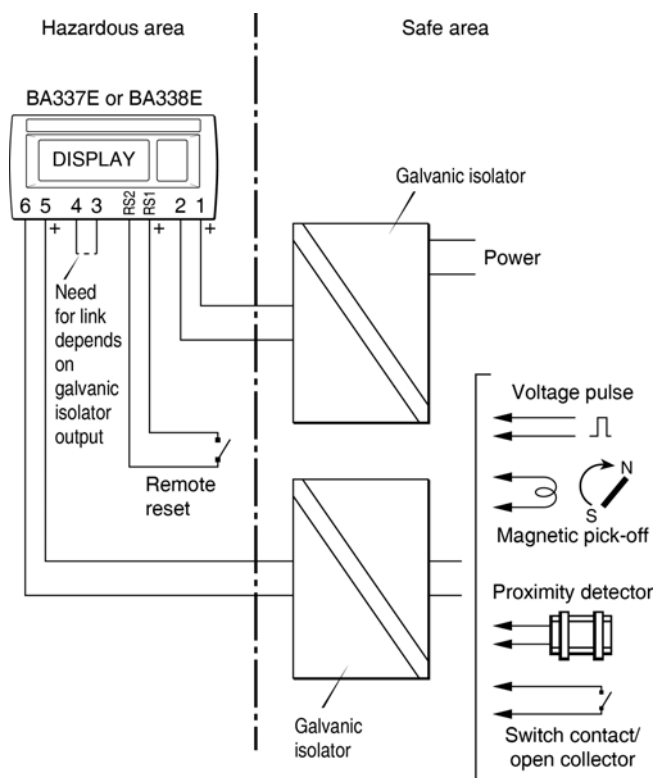

Fig 5 Pulse source in safe area

4.2.1 Power supply

The BA337E and the BA338E Rate Totalisers require a minimum of 10V between terminal 1 & 2 and consume:

	10mA	without optional backlight
plus	6mA	when terminals 3 & 4 are linked

Any galvanic isolator certified for the gas group and Zone in which the BA337E or BA338E is installed may be used to power the instrument. The output safety parameters of the isolator must be equal to or less than the input safety parameters of terminals 1 & 2 and the voltage at terminals 1 & 2 must be greater than 10V. These requirements are not restrictive and allow a wide range of galvanic isolators, such as solenoid drivers, to be used.

4.2.2 Pulse inputs

As shown in Figs 4 and 5 the BA337E and BA338E inputs can be directly connected to hazardous area flowmeters, or to safe area flowmeters via isolators. Galvanic isolators are not required in series with the input if an intrinsically safe flowmeter is located within the same hazardous area as the Rate Totaliser.

The BA337E and BA338E Rate Totaliser may be used with flowmeters having a wide variety of pulse outputs. The following table shows the switching thresholds for each type. For reliable operation the Rate Totalisers input signal must fall below the lower threshold and rise above the upper threshold.

Input transducer	Switching thresholds	
	Lower	Upper
Open collector	2k Ω	10k Ω
Voltage pulse low	1.0V	3.0V
Voltage pulse high	3.0V	10.0V
Magnetic pick-off	0mV	40mV peak
Proximity detector	1.2mA	2.1mA
Switch	100 Ω	1000 Ω

Switch contacts, proximity detectors and open collector sensors require energising which is achieved by linking terminals 3 and 4 together as shown in Figs 4 and 5.

4.2.3 Switch contact input

Any flowmeter with a magnetically activated switch contact output may be directly connected to input terminals 5 & 6 providing the flowmeter is located in the same hazardous area as the Rate Totaliser and the flowmeter and associated wiring can withstand a 500V rms insulation test to earth. Most magnetically activated reed relays used in turbine flowmeters comply with these requirements. The BA337E and BA338E contain a configurable debounce circuit to prevent contact bounce being counted. Three levels of de-bounce protection are independently available. See section 6.7.

4.2.4 Open collector input

Certified intrinsically safe flowmeters with an open collector output may be directly connected to input terminals 5 & 6 providing the flowmeter is located in the same hazardous area as the Rate Totaliser, and the flowmeter and associated wiring can withstand a 500V rms insulation test to earth.

The BA337E and BA338E contain a configurable debounce circuit to prevent false triggering. Three levels of de-bounce protection are independently available. See section 6.7.

4.2.5 2-wire proximity detector input

Most certified intrinsically safe flowmeters incorporating a NAMUR 2-wire proximity detector may be directly connected to a BA337E or BA338E input, providing the input safety parameters of the proximity detector are equal to or greater than the output safety parameters of a BA337E or BA338E input. The (flowmeter) proximity detector input safety parameters should be:

$$\begin{aligned} U_i &\geq 10.5V \text{ dc} \\ I_i &\geq 8.2\text{mA dc} \\ P_i &\geq 24\text{mW} \end{aligned}$$

and the minimum operating voltage of the flowmeter (proximity detector) is less than 7.5V. The flowmeter must be located in the same hazardous area as the Rate Totaliser and with the associated wiring be able to withstand a 500V rms insulation test to earth.

The BA337E and BA338E contain a configurable debounce circuit to prevent false triggering of the instrument. Three levels of de-bounce protection are available.

See section 6.7.

4.2.6 Magnetic pick-off input

Flowmeters incorporating a magnetic pick-off to sense flow will have a low level voltage output unless the flowmeter incorporates an amplifier. U_o , I_o in the BA337E and BA338E input configuration menu is a low level voltage pulse input intended for use with an intrinsically safe magnetic pick-off. When a Rate Totaliser input is configured for U_o , I_o and terminals 3 & 4 are not linked, input terminals 5 & 6 comply with the requirements for *simple apparatus* allowing connection to any certified intrinsically safe magnetic sensor having output parameters equal to or less than:

$$\begin{aligned} U_o &\leq 28V \text{ dc} \\ I_o &\leq 200\text{mA dc} \\ P_o &\leq 0.84\text{W} \end{aligned}$$

The maximum permitted cable parameters will be the flowmeter's C_o and L_o specified on its intrinsic safety certificate, less the Rate Totalisers pulse input parameters C_i and L_i which are small and can often be ignored.

The flowmeter must be located within the same hazardous area as the BA337E or BA338E and with the associated wiring must be able to withstand a 500V rms insulation test to earth.

The BA337E and BA338E contain a configurable debounce circuit to prevent false triggering of the instrument. See section 6.7.

4.2.7 Voltage pulse input

Two voltage pulse input ranges are independently selectable in the BA337E and BA338E Rate Totalisers configuration menu, $U_o L E 5 L$ and $U_o L E 5 H$. When configured for either of the voltage pulse ranges, and terminals 3 & 4 are not linked, the input terminals 5 & 6 comply with the requirements for *simple apparatus*. This allows the pulse input to be connected to any certified intrinsically safe flowmeter with a voltage output located within the same hazardous area as the Rate Totaliser providing it has output parameters equal to or less than:

$$\begin{aligned} U_o &\leq 28V \text{ dc} \\ I_o &\leq 200\text{mA dc} \\ P_o &\leq 0.84\text{W} \end{aligned}$$

The BA337E and BA338E Rate Totalisers may therefore be directly connected to most certified intrinsically safe flowmeters with a high level voltage output.

The maximum permitted cable parameters will be defined by the flowmeter's intrinsic safety C_o and L_o less the Rate Totaliser's pulse input parameters C_i and L_i which are small and can often be ignored.



The BA337E and BA338E contain a configurable debounce circuit to prevent false triggering of the instrument. Three levels of de-bounce protection are available.

See section 6.7.

4.2.8 Remote reset

The Rate Totaliser's total display may be remotely reset to zero by connecting terminals RS1 and RS2 together for more than one second. Permanent interconnection inhibits totalisation. Remote resetting may be accomplished by any mechanically operated switch located in the same hazardous area as the Rate Totaliser providing the switch and the associated wiring can withstand a 500V rms insulation test to earth. No galvanic isolator is required.

A BA337E or BA338E may also be remotely reset from the safe area. Any switch may be used but a galvanic isolator is required to transfer the contact closure into the hazardous area. Fig 4 illustrates how a BA337E or BA338E may be reset from both the safe and the hazardous area.

Note: Both Rate Totalisers may be configured to reset the total display to zero by operating the  and  push buttons simultaneously for more than two seconds in the totalising mode i.e. when the instrument is displaying flow. See 6.19

5. INSTALLATION

5.1 Location

Both models have a robust glass reinforced Noryl enclosure with a toughened glass window. The fronts of the Rate Totalisers have IP66 ingress protection and a gasket seals the joint between the instrument enclosure and the panel. The rear of both Rate Totalisers have IP20 ingress protection.

Figs 6A and 6B show the overall dimensions of the 96 x 48mm BA337E and the 144 x 72mm BA338E and the recommended panel cut-out dimensions. To achieve an IP66 seal between the instrument enclosure and the panel the smaller tolerance aperture must be used, and the BA338E must be secured with four panel mounting clamps.

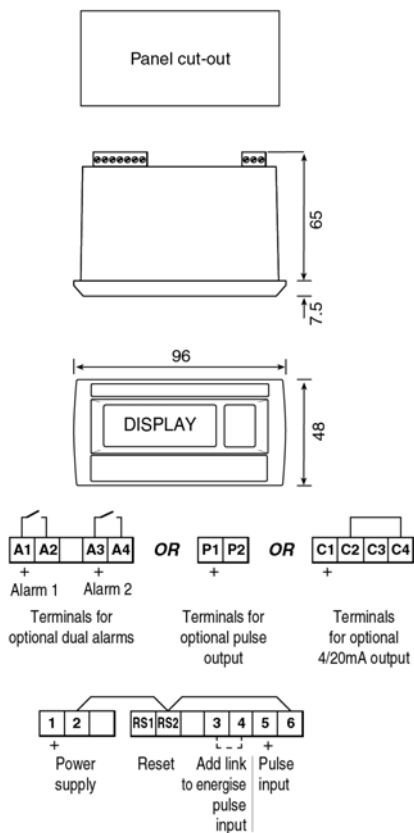

Cut-out dimensions

Recommended for all installations.
Mandatory to achieve an IP66 seal between the instrument and the panel
90 +0.5/-0.0 x 43.5 +0.5/-0.0

DIN 43 700
92.0 +0.8/ -0.0 x 45 +0.6 -0.0

Support panel wiring to prevent vibration damage

Note: Optional backlight is internally powered

Fig 6A BA337E dimensions & terminals

Cut-out dimensions

Recommended for all installations.
Mandatory to achieve an IP66 seal between the instrument and the panel
136.0 +0.5/-0.0 x 66.2 +0.5/-0.0

DIN 43 700
138.0 +1.0/-0.0 x 68.0 +0.7/-0.0

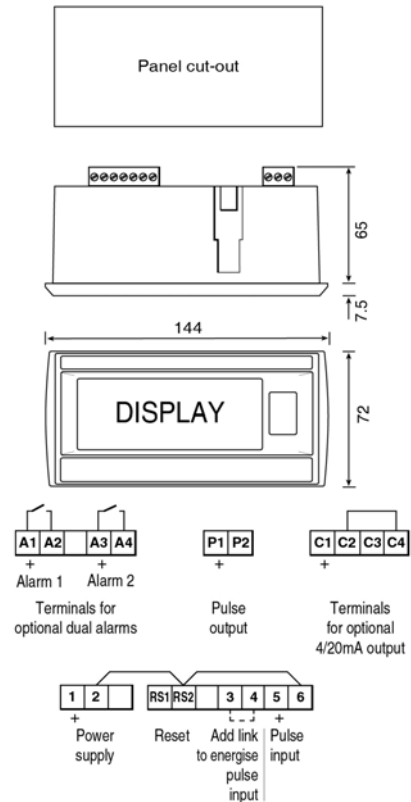

Support panel wiring to prevent vibration damage

Note: Optional backlight is internally powered

Fig 6B BA338E dimensions & terminals

Although the front of both Rate Totalisers have IP66 protection, they should be shielded from direct sunlight and severe weather conditions.

The Rate Totalisers may be installed in any panel providing that the operating temperature is between -40°C and +70°C and the intrinsic safety requirements are complied with. At temperatures below -20°C the display digits will change more slowly and contrast will be reduced, but the instruments will continue to function and totalise.

5.2 EMC

The BA337E and BA338E comply with the requirements of the European EMC Directive 2014/30/EU. For specified immunity all wiring should be in screened twisted pairs, with the screens earthed at one point within the safe area.

5.3 Installation Procedure

- Cut the specified aperture in the panel. To achieve an IP66 seal between the instrument enclosure and the instrument panel the aperture must have the tighter tolerances specified in Figs 6A and 6B.
- Slide the gasket over the body of the Rate Totaliser before inserting the instrument into the panel aperture.
- Firstly ensure that all the panel mounting clamps are closed by turning the knurled screws fully anti clockwise until the two pips in the clamp foot align with holes in the clamp body.
- Place a clamp in the recess on each side of the Rate Totaliser, pulling gently to slide it onto the dovetail as shown in Fig 7. Push the knurled screw slightly forward to engage the thread and tighten by turning clockwise until it is just finger tight. When the clamps are fitted ensure that the gasket behind the front panel bezel is correctly positioned before fully tightening the clamps to secure the instrument. The maximum recommended clamp tightening torque is 22cNm (1.95 lbf in) which is approximately equivalent to finger-tight plus one half turn. **Do not over tighten.**
- Four panel mounting clamps are required to achieve an IP66 seal between a BA338E and the instrument panel.
- Connect the panel wiring to the rear terminal block(s) as shown in Figs 6A and 6B. To simplify installation, the terminals are removable so that the panel wiring can be completed before the instrument is installed. To prevent vibration damage **ensure that panel wiring is supported.**

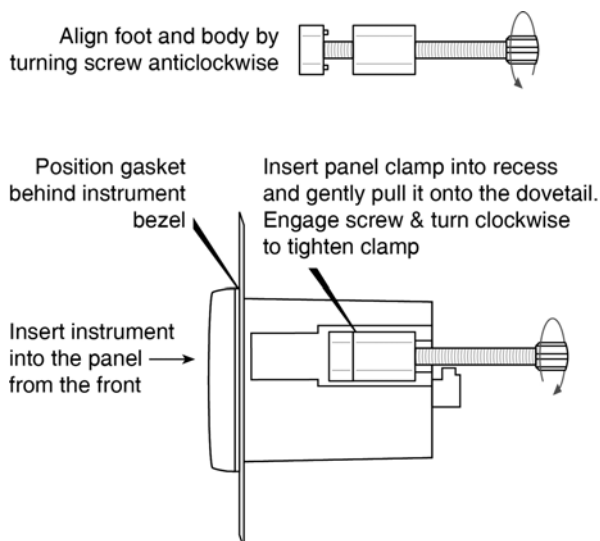

Fig 7 Fitting panel mounting clamps

5.4 Scale card

The Rate Totaliser's units of measurement are shown on a printed scale card in a window at the right hand side of the display. The scale card is mounted on a flexible strip that is inserted into a slot at the rear of the instrument as shown in Fig 8. Thus the scale card can easily be changed without removing the Rate Totaliser from the panel or opening the instrument enclosure.

New Rate Totalisers are supplied with a printed scale card showing the requested units of measurement, if this information is not supplied when the instrument is ordered a blank card will be fitted.

A pack of self-adhesive scale cards printed with common units of flow measurement is available as an accessory from BEKA associates. Custom printed scale cards can also be supplied.

To change a scale card, unclip the tapered end of the flexible strip at the rear of the instrument by gently pushing it upwards and pulling it out of the enclosure. Peel the existing scale card from the flexible strip and replace it with a new printed card, which should be aligned as shown below. Do not fit a new scale card on top of an existing card.

Install the new scale card by gently pushing the flexible strip into the slot at the rear of the Rate Totaliser, when it reaches the internal end-stop secure it by pushing the end of the flexible strip downwards so that the tapered section is held by the rear panel.

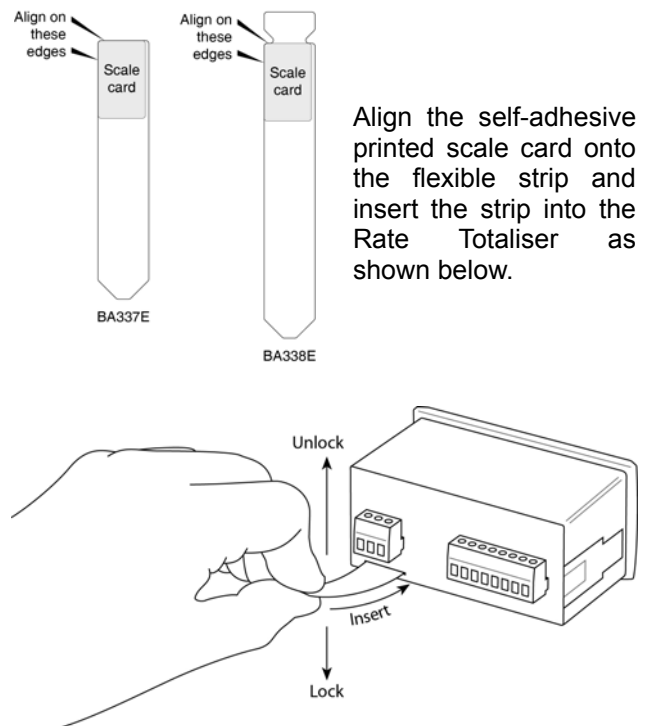

Fig 8 Inserting the flexible strip carrying the scale card into slot at the rear of Rate Totaliser.

6.0 CONFIGURATION & CALIBRATION

The BA337E and BA338E Rate Totalisers are configured and calibrated via four front panel push buttons. All the configuration functions are contained in an easy to use intuitive menu that is shown diagrammatically in Fig 10.

Each menu function is summarised in section 6.3 of this manual and each summary includes a reference to more detailed information. The sixteen segment lineariser is described separately in section 7.

Configuration of the isolated pulse output, which is fitted to all BA338E Rate Totalisers but is an option on the BA337E, and the optional alarms and 4/20mA output are described separately in section 10. When fitted they appear as additional functions within the configuration menu.

All new Rate Totalisers are supplied calibrated as requested at the time of ordering. If calibration is not requested, Rate Totalisers will have default configuration as shown in the following table, but can easily be re-configured on-site.

Function	Display	Default
Access code	[odE	0000
Function	Funct, on	Std
Input	inp, TYPE	oP, CoL
Debounce	dEbounCE	dEFruLt
Update	uPdRtE	0.5
Upper display	di, SP-1	totRL
Lower display	di, SP-2	on
Decimal point	dP	Rate 00 Total 0
K Factor	FACtor	1.0
Total scale factor	SCALE.t	1.0
Rate scale factor	SCALE.r	1.0
Timebase	t-base	SEC
Filter	F, LtEr	24
Clip-off	CLP-off	0
Local total reset	t-rESEt	oFF
Local grand total reset	Gt-rESEt	oFF
Security code	[odE	0000

Note: While the instrument is being configured totalisation continues so that any flow occurring during this time is recorded.

6.1 Configuration structure

Fig 9 shows the BA337E and BA338E calibration structure. The rate and total display calibrations are independent which allows the displays to have different engineering units.

The rate totaliser pulse input is divided by FACTor which is usually set to the K-factor of the flowmeter, thus converting the flowmeter output into engineering units. When the 16 segment lineariser L, n is selected in the Function sub-menu, up to 16 values for FACtor may be entered each at a specified input pulse frequency to compensate for flowmeter nonlinearity. See section 7.

SCALE.r is a dividing factor that converts the output from FACtor into the required rate display in engineering units. e.g. if the output from FACtor is one pulse per litre and the rate display is required in gallons, SCALE.r should be set to 4.5461 which is the number of litres in an imperial gallon.

The timebase t-base is a multiplying factor that determines if the instrument displays flow per second, per minute or per hour.

The total flow display is independent of the rate display. SCALE.t is a dividing factor that converts the output from FACtor into the required total display engineering units. e.g. if the output from FACtor is one pulse per litre and the total display is required in thousands of gallons, SCALE.t should be set to 4546.1 which is the number of litres in 1,000 imperial gallons.

The BA337E and the BA338E uses 'real' decimal points. Moving the position of a decimal point in a scale factor will affect the instrument calibration.

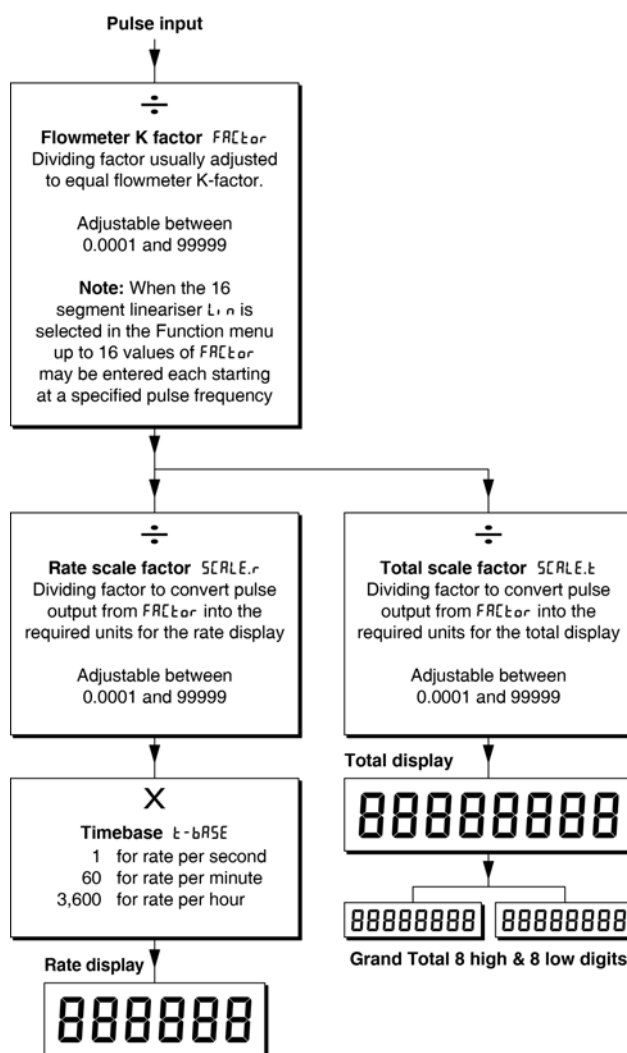















Fig 9 Calibration structure

6.2 Accessing configuration functions

Throughout this manual push buttons are shown as , ,  and  and legends displayed by the instrument are shown in a seven segment font exactly as they appear on the instrument display e.g. r nPUL and uPdRE .

Access to the configuration menu is obtained by operating the  and  push buttons simultaneously. If the instrument is not protected by a security code the first parameter FUNcti on will be displayed. If a security code other than the default code 0000 has already been entered, the instrument will display CodE . Press  to clear this prompt and enter the security code for the instrument using the  or  push button to adjust each digit, and the  push button to transfer control to the next digit. If the correct code has been entered pressing  will cause the first parameter FUNcti on to be displayed. If an incorrect code is entered, or a push button is not operated within ten seconds, the instrument will automatically return to the totalisation mode.

All configuration functions and prompts are shown on the upper eight digit display.

Once within the main configuration menu the required parameter can be selected by scrolling through the menu using the  or  push button. The configuration menu is shown diagrammatically in Fig 10.





When returning to the totalisation mode following reconfiguration, the Rate Totaliser will display dRE followed by SRUE while the new information is stored in permanent memory.

6.3 Summary of configuration functions

This section summarises all the configuration functions. When read in conjunction with Fig 10 it provides a quick aid for configuring the Rate Totaliser. If more detail is required, each section contains a reference to a full description of the function.

Display	Summary of function
FUNcti on	<p>Rate Totaliser function Defines the relationship between the pulse input and the Rate Totaliser display. May be set to:</p> <ul style="list-style-type: none"> Std Standard linear relationship Lin 16 segment adjustable lineariser - see section 7. <p>See section 6.4</p>
r nPUL	<p>Input Contains sub-menu with two functions</p> <ul style="list-style-type: none"> r nP.ETYPE Select Input type dEbou nCE Set debounce <p>See section 6.5</p>
	<p>r nP.ETYPE Configures the Rate Totaliser to accept one of six types of input:</p> <ul style="list-style-type: none"> OP COL Open collector * VOLT PULSE L Voltage pulse <1 >3V VOLT PULSE H Voltage pulse <3 >10V MAGNETIC Magnetic pick-off PROX DET Proximity detector * SWITCH CONTACT Switch contact * <p>* Link terminals 3 & 4 See section 6.6</p>
	<p>dEbou nCE Defines level of input debounce applied to the pulse input to prevent false counting:</p> <ul style="list-style-type: none"> dEFRAUL HEAVY LIGHT <p>See section 6.7</p>
uPdRE	<p>Display update interval Define the interval between display updates between 0.5 and 5 seconds. See section 6.8</p>

Display	Summary of function	Display	Summary of function
d, 5P-1	<p>Upper display Defines whether <i>rATE</i> or <i>tOTAL</i> is shown on the upper display. The other variable will be shown on the lower display, providing the lower display is <i>on</i> in function d, 5P-2. See section 6.9</p>	SCALEr	<p>Rate scale factor <i>SCALE.r</i> is a dividing factor that converts the pulse output from <i>FREtOr</i> into the required rate display in engineering units. e.g. if the output from <i>FREtOr</i> is one pulse per litre and the rate display is required in gallons, <i>SCALE.r</i> should be set to 4.546 l which is the number of litres in an imperial gallon. <i>SCALE.r</i> may be adjusted between 0.000 l and 99999. The flow rate display is independent of the total flow display. See section 6.14</p>
d, 5P-2	<p>Lower display Turns the lower display, which normally shows rate, <i>on</i> or <i>oFF</i>. See section 6.10</p>	t-bASE	<p>Timebase Selectable multiplier allowing flow rate to be displayed in units per second, per minute or per hour. Select: <ul style="list-style-type: none"> tB-0 l for flow / second tB-50 for flow / minute tB-3600 for flow / hour See section 6.15</p>
dP	<p>Decimal points Defines the position of the decimal point in both the rate and total displays. See section 6.11</p>	F, LLEr	<p>Display filter An adjustable digital filter to reduce noise on the rate display is controlled by two parameters each adjustable between 0 and 9. The first digit defines the amount of filtering applied to the display, the second deviation from the displayed rate at which the filter will be overridden and the rate display will move rapidly to the new value. See section 6.16</p>
FREtOr	<p>Flowmeter K-factor The rate totaliser pulse input is divided by <i>FREtOr</i>, which is usually set to the K-factor of the flowmeter, thus converting the flowmeter output into engineering units. <i>FREtOr</i> may be adjusted between 0.000 l and 99999. When the 16 segment lineariser <i>L, n</i> is selected in the Function sub-menu, up to 16 values for <i>FREtOr</i> may be entered, each at a specified input pulse frequency to compensate for flowmeter non-linearity. See section 6.12</p>	CLP-oFF	<p>Clip-off To prevent totalisation of very low flow rates, clip-off enables the user to select a flow rate display below which totalisation is inhibited. See section 6.17</p>
SCALEt	<p>Total Scale Factor <i>SCALE-t</i> is a dividing factor that converts the pulse output from <i>FREtOr</i> into the required total display in engineering units. e.g. if the output from <i>FREtOr</i> is one pulse per litre and the total display is required in thousands of gallons, <i>SCALE-t</i> should be set to 4546. l which is the number of litres in 1,000 imperial gallons. <i>SCALE-t</i> may be adjusted between 0.000 l and 99999. The total flow display is independent of the rate display. See section 6.13</p>		

Display	Summary of function	Display	Summary of function
LoL [Lr	<p>Local reset Contains sub-menu with two functions enabling total and grand total to be reset to zero via the front panel push buttons when the Rate Totaliser is in the totalisation mode. See section 6.18</p> <p>Local total reset [Lr tot When on is selected total display is reset when  and  buttons are operated simultaneously for more than 3 seconds in the operating mode. See section 6.19</p> <p>Local grand total reset [Lr Gtot When on is selected the grand total is reset when  +  buttons are operated simultaneously for more than 10 seconds in the operating mode. Note: Once reset, the grand total can not be restored. See section 6.20</p>	[Lr-Gtot	<p>Reset grand total from configuration menu. This function resets the grand total to zero from within the configuration menu when [Lr YE5 is selected, and 5urE is entered to confirm the instruction. Note: Once reset, the grand total can not be recovered. See section 6.21</p>
		[odE	<p>Security code Defines a four digit alphanumeric code which must be entered to gain access to the configuration menu. Default code 0000 disables the security function and allows unrestricted access to all configuration functions. See section 6.22</p>
		r5Et dEF	<p>Reset to factory defaults Returns the Rate Totaliser configuration functions to the factory default shown in section 6. To prevent accidental use the request must be confirmed by entering 5urE before the reset will be executed. See section 6.23</p>

6.4 Rate Totaliser function: $F_{UN}[\xi, \sigma n]$

The Rate Totaliser contains an adjustable sixteen segment lineariser which may be used to compensate for flowmeter non-linearity. This function turns this lineariser σn or σFF .

$\xi \xi d$ Lineariser not activated
 $\xi \xi n$ Lineariser activated

To reveal the existing Rate Totaliser function select $F_{UN}[\xi, \sigma n]$ from the configuration menu and press $\langle P \rangle$. If the function is set as required, press $\langle E \rangle$ to return to the configuration menu, or press the $\langle \nabla \rangle$ or $\langle \blacktriangle \rangle$ button to change the setting, followed by the $\langle E \rangle$ button to return to the $F_{UN}[\xi, \sigma n]$ prompt in the configuration menu.

$\xi \xi d$ Linear

Provides a linear relationship between the pulse input and the Rate Totaliser displays.

$\xi \xi n$ 16 segment adjustable lineariser

Enables a sixteen segment adjustable lineariser. When $\xi \xi n$ is selected the $F_{RE}[\xi, \sigma r]$ function is expanded to allow up to 16 values to be entered for different input pulse frequencies. Detailed information about the lineariser including configuration is contained in section 7 of this instruction manual.

6.5 Input: $\sigma n P_{UL}$

The Input function contains two sub-functions $\sigma n P_{TYPE}$ and $\sigma n P_{NOISE}$ which configure the Rate Totaliser input and input noise rejection.

6.6 Input type: $\sigma n P_{TYPE}$

$\sigma n P_{TYPE}$ is a sub-menu in the $\sigma n P_{UL}$ function which defines the type of flowmeter or input pulse that the Rate Totaliser will count. To check or change the type of input, select $\sigma n P_{UL}$ in the main configuration menu and press $\langle P \rangle$ which will reveal the $\sigma n P_{TYPE}$ prompt, pressing $\langle P \rangle$ again will show the Rate Totaliser input. If set as required press $\langle E \rangle$ twice to return to the configuration menu, or repeatedly press the $\langle \nabla \rangle$ or $\langle \blacktriangle \rangle$ button until the required type of input is displayed, then press $\langle E \rangle$ twice to return to the configuration menu.

One of following six types of input may be selected:

		Switching thresholds	
		Low	High
$\sigma P [\sigma L]$	Open collector ²	2	10k Ω
$\xi \sigma L \xi S L$	Voltage pulse low ¹	1	3V
$\xi \sigma L \xi S H$	Voltage pulse high ¹	3	10V
$\xi \sigma L$	Magnetic pick-off	0	40mV
$P_{r.dE}[\xi]$	Proximity detector ²	1.2	2.1mA
$\xi \sigma n \xi R[\xi]$	Switch contact ²	100	1000 Ω

Notes:

1. Maximum voltage input +30V.
2. For flowmeter transducers that require energising i.e. proximity detectors, switch contacts or open collectors, terminals 3 & 4 of the Rate Totaliser should be linked together.
3. To count correctly, the input pulse must fall below the lower switching threshold and rise above the higher switching threshold.
4. See section 6.7 for maximum counting frequency.

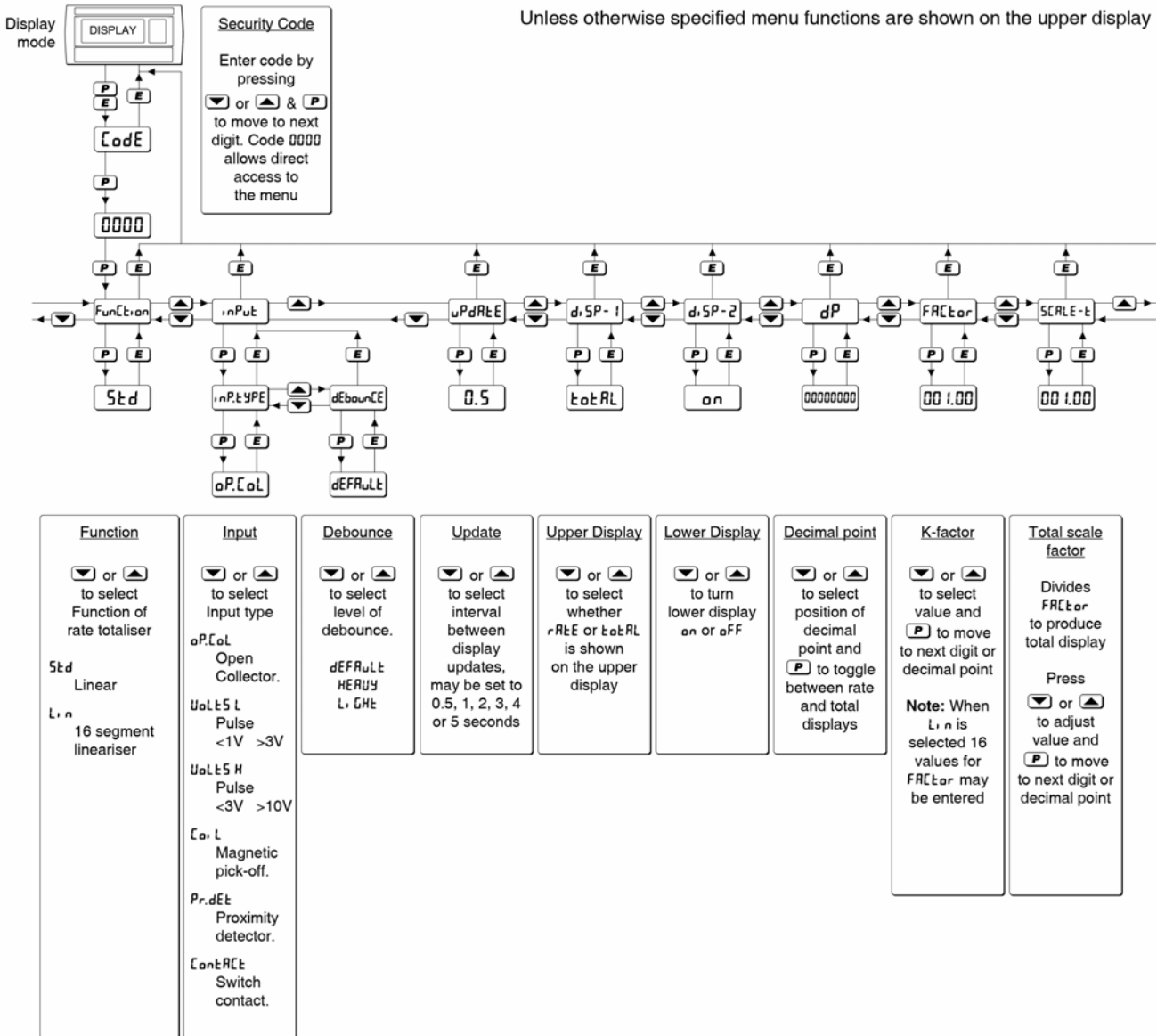
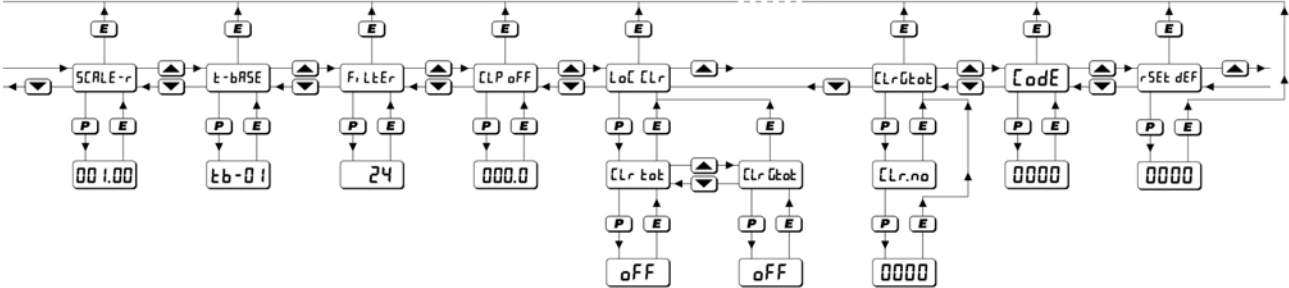

Fig 10 Configuration menu

When fitted optional alarms, pulse output and 4/20mA output functions appear here.



<p>Rate scale factor</p> <p>Divides FACTOR to produce rate display</p> <p>Press <input type="button" value="▼"/> or <input type="button" value="▲"/> to adjust value and <input type="button" value="P"/> to move to next digit or decimal point</p>	<p>Timebase</p> <p><input type="button" value="▼"/> or <input type="button" value="▲"/> to select rate display timebase</p> <p>tb-01 for flow/sec</p> <p>tb-60 for flow/min</p> <p>tb-3600 for flow/hour</p>	<p>Filter</p> <p><input type="button" value="▼"/> or <input type="button" value="▲"/> to adjust value of each digit and <input type="button" value="P"/> to transfer control to other digit</p> <p>First digit: filter magnitude</p> <p>second digit: step response</p> <p>Note: While making adjustments the filtered rate display is shown on lower display so stability can be assessed</p>	<p>Clip off</p> <p>Rate display below which totalisation is inhibited</p> <p>Press <input type="button" value="▼"/> or <input type="button" value="▲"/> to adjust value of each digit and <input type="button" value="P"/> to move to next digit</p>	<p>Local total reset</p> <p><input type="button" value="▼"/> or <input type="button" value="▲"/> to turn the local total reset function on or off. When on, total display is reset to zero when <input type="button" value="▼"/> and <input type="button" value="▲"/> are operated simultaneously in display mode for more than 3 seconds</p>	<p>Local grand total reset</p> <p><input type="button" value="▼"/> or <input type="button" value="▲"/> to turn the local grand total reset function on or off. When on, grand total display may be reset to zero when <input type="button" value="E"/> and <input type="button" value="▲"/> are operated simultaneously in display mode for more than 10 seconds</p>	<p>Clear grand total</p> <p>Press <input type="button" value="▼"/> or <input type="button" value="▲"/> to select YES to reset grand total to zero</p> <p>Confirm instruction by entering SurE. Press <input type="button" value="▼"/> or <input type="button" value="▲"/> to adjust each digit and <input type="button" value="P"/> to move to next digit</p>	<p>Define Security Code</p> <p>Enter by pressing <input type="button" value="▼"/> or <input type="button" value="▲"/> and <input type="button" value="P"/> to move to next digit</p>	<p>Reset configuration to factory defaults</p> <p>Confirm instruction by entering SurE. Press <input type="button" value="▼"/> or <input type="button" value="▲"/> to adjust each digit and <input type="button" value="P"/> to move to next digit</p>
--	---	--	---	--	---	--	---	---

6.7 Debounce: $dE_{boun}EE$

$dE_{boun}EE$ is an adjustable sub-menu in the r_{nput} function which prevents the Rate Totaliser miscounting when the input pulse has noisy edges, such as those resulting from a mechanical contact closing and bouncing. Three levels of protection may be selected and the amount of debounce applied depends upon the type of Rate Totaliser input that has been selected in the $r_{nput}TYPE$ function.

The following table shows the minimum time that the input pulse must be continuously above the upper input switching threshold and continuously below the lower switching threshold to ensure that the Rate Totaliser processes the input pulse. Input switching thresholds are shown in section 4.1.2.

De-bounce level	Min input pulse width	
	Type of Input	
	Contact	All others
Default	1600 μ s	40 μ s
Heavy	3200 μ s	350 μ s
Light	400 μ s	5 μ s

The Rate Totaliser's maximum counting frequency depends upon the debounce level selected, the shape of the input pulse and its amplitude. The following table assumes a square wave input and is only for guidance. The maximum counting frequency will be lower if the input pulses have sloping edges and the pulse amplitude only slightly exceeds the input switching thresholds.

ONLY FOR GUIDANCE		
De-bounce level	Max counting frequency	
	Type of input	
	Contact	All others
Default	250Hz	12kHz
Heavy	120Hz	2kHz
Light	1000Hz	100kHz

The minimum input frequency is 0.01Hz. Below this frequency the rate display will be forced to zero.

The $dE_{boun}EE$ function is a sub-menu located in the r_{nput} function. Select r_{nput} in the configuration menu and press $\langle P \rangle$ which will reveal the $r_{nput}TYPE$ prompt, press the \blacktriangledown or \blacktriangleleft button to select $dE_{boun}EE$ followed by $\langle P \rangle$ to reveal the existing setting. Pressing the \blacktriangledown or \blacktriangleleft button will scroll through the three levels. When the required level has been selected, pressing $\langle E \rangle$ twice will enter the selection and return the display to the r_{nput} prompt in the configuration menu.

6.8 Display update interval: $r_{pd}RE$

If either the rate or the total display is likely to change rapidly, a longer interval between display updates may simplify reading the Rate Totaliser display. This function allows one of six different display intervals between 0.5 and 5 seconds to be selected. The selected display update interval does not affect the update time of any other instrument function.

To adjust the update interval select $r_{pd}RE$ from the configuration menu and press $\langle P \rangle$ to reveal the existing time. Pressing the \blacktriangledown or \blacktriangleleft button will scroll through the six times. When the required interval has been selected press $\langle E \rangle$ to enter the selection and return to the configuration menu.

6.9 Upper display: d_{5P-1}

Usually total flow is shown on the larger upper eight digit display, but this function allows rate to be shown on the upper display and total on the smaller lower display which can show six positive digits.

To check the status of the upper display, select d_{5P-1} from the configuration menu and press $\langle P \rangle$ which will reveal if the display is showing r_{RE} or $t_{o}RE$. The setting can be changed by pressing the \blacktriangledown or \blacktriangleleft button followed by the $\langle E \rangle$ button to enter the selection and return to the configuration menu.

6.10 Lower display: d_{5P-2}

This function turns the lower display *on* or *off*. When turned *off*, the BA337E or the BA338E will only have one eight digit display which may be configured in the d_{5P-1} function to show total flow or rate of flow.

To check the status of the lower display, select d_{5P-2} from the configuration menu and press $\langle P \rangle$ to reveal if the lower display is *on* or *off*. The setting may be changed by pressing the \blacktriangledown or \blacktriangleleft button followed by the $\langle E \rangle$ button to enter the selection and return to the configuration menu.

6.11 Position of the decimal points: dP

The upper and lower displays have eight and six digits respectively. This function enables the position of the decimal point on both displays to be independently positioned.

To adjust the position of the decimal points select dP from the configuration menu and press P . The upper display defined as the rate or total display by function $d, SP-1$ (section 6.9) will be activated and identified by the display annunciator as Rate or Total. The decimal point is positioned by operating the \blacktriangledown or \blacktriangleleft push button.

In the total display the \blacktriangledown button moves the position of the decimal point to the left and the \blacktriangleleft button moves it to the right. It may be positioned between any of the 8 digits or absent by moving it to the right of the least significant digit.

When the decimal point in the upper display has been positioned pressing the P button will transfer control to the lower display variable, but it will be shown and annunciated on the larger upper display. The position of the decimal point may be positioned in the same way between any of the five right hand digits or absent by operating the \blacktriangledown or \blacktriangleleft push buttons. When set as required enter the settings and return to the configuration menu by operating the E button.

6.12 Flowmeter K-factor: FRC_{tor}

The rate totaliser pulse input is divided by FRC_{tor} , which is adjustable between 0.0001 and 99999, for flow applications FRC_{tor} should be set to the K-factor of the flowmeter. K-factor is the number of pulses that the flowmeter produces per unit volume of flow e.g. 20 pulses per litre, FRC_{tor} therefore converts the flowmeter output into engineering units ready for further scaling to produce the required rate and total flow displays. See Fig 9.

When the 16 segment lineariser L_{16} is selected in $F_{\text{un}}L_{16}$ up to 16 values of FRC_{tor} may be entered, each at a specified input pulse frequency to compensate for flowmeter non-linearity. See section 7 of this manual.

To check or change the value select FRC_{tor} from the configuration menu and press P which will reveal the existing value with one digit flashing.

The flashing digit may be adjusted by pressing the \blacktriangledown or \blacktriangleleft button. When this digit has been adjusted pressing P will transfer control to the next digit. When all the digits have been adjusted pressing P will transfer control to the decimal point that may be positioned between any of the digits, or may be omitted by moving it to the right of the least significant digit. When set as required, press E to return to the FRC_{tor} prompt in the configuration menu.

6.13 Total scale factor: $SCALE_{\text{t}}$

$SCALE_{\text{t}}$ is a dividing factor adjustable between 0.0001 and 99999 that enables total flow to be displayed in the required engineering units. e.g. if the output from FRC_{tor} is one pulse per litre and the total display is required in thousands of gallons, $SCALE_{\text{t}}$ should be set to 4546.1 which is the number of litres in 1,000 imperial gallons. The total flow display is independent of the rate display.

To check or change the total scale factor select $SCALE_{\text{t}}$ from the configuration menu and press P which will reveal the existing value with one digit flashing. The value of the flashing digit may be changed by pressing the \blacktriangledown or \blacktriangleleft button. When this digit has been adjusted as required, pressing P will transfer control to the next digit. When all the digits have been adjusted pressing P will transfer control to the decimal point that may be positioned between any of the digits, or may be omitted by moving it to the right of the least significant digit. When the required total scale factor has been entered, press E to return to the $SCALE_{\text{t}}$ prompt in the configuration menu.

6.14 Rate scale factor: $SCALE_{\text{r}}$

$SCALE_{\text{r}}$ is a dividing factor adjustable between 0.0001 and 99999 that enables the flow rate to be displayed in the required engineering units. e.g. if the output from FRC_{tor} is one pulse per litre and the rate display is required in gallons, $SCALE_{\text{r}}$ should be set to 4.5461 which is the number of litres in an imperial gallon.

The units of the rate display are volume per unit of time. The unit of time is the timebase of the instrument which is determined by $t\text{-BASE}$ described in section 6.15.

To check or change the rate scale factor select $SCALE_{\text{r}}$ from the configuration menu and press P which will reveal the existing value with one digit flashing. The value of the flashing digit may be changed by pressing the \blacktriangledown or \blacktriangleleft button. When this digit has been adjusted as required, pressing P will transfer control to the next digit. When all the digits have been adjusted pressing P will transfer control to the decimal point which may be positioned between any of the digits, or may be omitted by moving it to the right of the least significant digit. When the required rate scale factor has been entered, press E to return to the $SCALE_{\text{r}}$ prompt in the configuration menu.

6.15 Timebase: ϵ -bR5E

The timebase multiplies the rate display by 1, 60 or 3,600 depending upon whether the Rate Totaliser is required to display rate per second, per minute or per hour. See Fig 9.

To check or change the timebase, select ϵ -bR5E from the configuration menu and press P which will reveal the existing setting. Pressing the \blacktriangledown or \blacktriangle button will scroll through the three options:

ϵ b-1	for flow / second
ϵ b-60	for flow / minute
ϵ b-3600	for flow / hour

When the required multiplier is displayed press E to return to the ϵ -bR5E prompt in the configuration menu.

6.16 Display filter: F, LkEr

The digital display filter has two independent adjustable parameters enabling the rate display response to be tailored for optimum performance. The filter parameters are controlled by a two digit number. The first digit defines the amount of filtering applied to the display as shown below.

First digit	Filter time constant seconds
0X	0
1X	1.3
2X	4.3
3X	6.5
4X	8.7
5X	11.3
6X	15.7
7X	20.9
8X	25.2
9X	31.5

The second digit defines the deviation from the displayed rate at which the filter will be overridden and the rate display will move rapidly to the new value.

Second digit	Magnitude of step change which will produce a rapid response
X0	off
X1	1%
X2	2%
X3	4%
X4	8%
X5	12%
X6	16%
X7	24%
X8	32%
X9	64%

By careful adjustment of the two parameters a stable display with an acceptable input step response can be obtained for most applications.

During commissioning it is recommended that initially the second digit is set to 0 (off) and the first digit is adjusted to provide acceptable rate display stability. The second digit should then be increased until the selected step size is greater than the noise on the display signal, at which setting the rate display will become stable. These will be the optimum filter parameters for acceptable rate display stability and a fast response to a large rate signal change.

To check or change the filter select F, LkEr in the configuration menu and press P which will reveal the existing settings with the first digit flashing. Pressing the \blacktriangledown or \blacktriangle button will change the flashing digit and P will transfer control to the second digit. While making adjustments the filtered rate display is shown on the lower display so that stability can be assessed while adjustments are being made. When set as required, press the E button to enter the revised parameters and return to the F, LkEr prompt in the configuration menu.

6.17 Clip-off: [LP oFF

To prevent totalisation of very low flow rates that over long periods may result in significant totalisation errors, the BA337E and the BA338E may be configured to stop totalising when the flow rate falls below an adjustable threshold.

To check or change the clip-off threshold select [LP oFF from the configuration menu and press P which will reveal the current setting. The threshold is shown in the units already selected for the flow rate display. One digit will be flashing. The value of the flashing digit may be changed by pressing the \blacktriangledown or \blacktriangle button. When this digit is correct pressing P will transfer control to the next digit. When clip-off is set as required, press the E button to enter the revised figure and return to the [LP oFF prompt in the configuration menu.

When the flow rate falls below the clip-off threshold, the rate display will show zero flow, totalisation will stop and the HOLD annunciator will be activated. The flow indicator will continue to rotate for 2 seconds each time an input pulse is received i.e. at input pulse frequencies above 0.5Hz it will appear to rotate continuously.

Note:

To avoid confusion, when the K-factor $FRC\epsilon\sigma r$, rate scale factor $5[RL\epsilon.r$, timebase ϵ -bR5E, or the position of the rate display decimal point are changed, clip-off will automatically be reset to zero. A new clip-off threshold must therefore be entered after any of these functions have been adjusted.

6.18 Local reset: $\text{L}\alpha\text{C} \text{C}\text{Lr}$

The Local reset function contains two sub-functions $\text{C}\text{Lr} \text{t}\alpha\text{t}$ and $\text{C}\text{Lr} \text{G}\text{t}\alpha\text{t}$ which when enabled allow the total display and grand total to be reset to zero via the instrument push buttons while the Rate Totaliser is in the totalisation mode.

6.19 Local total reset: $\text{C}\text{Lr} \text{t}\alpha\text{t}$

$\text{C}\text{Lr} \text{t}\alpha\text{t}$ is a sub-menu in the $\text{L}\alpha\text{C} \text{C}\text{Lr}$ function which when activated allows an operator to reset the total display to zero while in the totalisation mode by operating the \blacktriangledown and \blacktriangle push buttons simultaneously for more than three seconds.

Select $\text{L}\alpha\text{C} \text{C}\text{Lr}$ in the configuration menu and press P which will reveal the $\text{C}\text{Lr} \text{t}\alpha\text{t}$ prompt and operate P again which will show if the local total reset is on or off . If set as required operate the E button twice to return to the configuration menu, or the \blacktriangledown or \blacktriangle button to change the setting followed by the E button twice to enter the change and return to the $\text{L}\alpha\text{C} \text{C}\text{Lr}$ prompt in the configuration menu.

Note:

The total display may also be reset to zero remotely by connecting terminals RS1 and RS2 together for more than one second. See sections 3.6; 4.1.8 and 4.2.8 of this manual.

6.20 Local grand total reset: $\text{C}\text{Lr} \text{G}\text{t}\alpha\text{t}$

The grand total is a separate sixteen digit counter which is incremented in parallel with the total display, but is not zeroed when the total display is reset to zero. The grand total may be viewed in the totalisation mode in two eight digit sections as described in section 2.2 of this manual.

$\text{C}\text{Lr} \text{G}\text{t}\alpha\text{t}$ is a sub-menu in the $\text{L}\alpha\text{C} \text{C}\text{Lr}$ function which when activated allows the operator to reset the grand total display to zero in the totalisation mode by operating the E and \blacktriangle push buttons simultaneously for more than ten seconds.

Select $\text{L}\alpha\text{C} \text{C}\text{Lr}$ in the configuration menu and press P which will reveal $\text{C}\text{Lr} \text{t}\alpha\text{t}$. Using the \blacktriangledown or \blacktriangle button to select $\text{C}\text{Lr} \text{G}\text{t}\alpha\text{t}$ and press P which will show if local grand total reset is on or off . If set as required operate the E button twice to return to the configuration menu, or the \blacktriangledown or \blacktriangle button to change the setting followed by the E button twice to enter the change and return to the $\text{L}\alpha\text{C} \text{C}\text{Lr}$ prompt in the configuration menu.

6.21 Grand total reset from configuration menu: $\text{C}\text{Lr} \text{G}\text{t}\alpha\text{t}$

The grand total is a separate sixteen digit counter which is incremented in parallel with the total display, but is not zeroed when the total display is reset to zero. The grand total may be viewed in the totalisation mode in two eight digit sections as described in section 2.2 of this manual.

The grand total can be reset to zero from within the configuration menu using this $\text{C}\text{Lr} \text{G}\text{t}\alpha\text{t}$ function, or from the totalisation mode if sub-function $\text{C}\text{Lr} \text{G}\text{t}\alpha\text{t}$ in the $\text{L}\alpha\text{C} \text{C}\text{Lr}$ function is activated - see 6.20.

To zero the grand total from within the configuration menu select $\text{C}\text{Lr} \text{G}\text{t}\alpha\text{t}$ and press P which will cause the instrument to display $\text{C}\text{Lr} . \text{no}$ with no flashing. Press the \blacktriangledown or \blacktriangle push button until $\text{C}\text{Lr} . \text{9E5}$ is displayed and then press P which will result in a 0000 prompt being displayed with the first digit flashing. This is a request for the instruction to be confirmed by entering SURE using the \blacktriangledown or \blacktriangle buttons and the P button to move control to the next digit. Pressing E will then reset the grand total to zero and return the Rate Totaliser to the configuration menu.

Note:

Once reset, the grand total can not be recovered.

6.22 Security code: $\text{C}\alpha\text{dE}$

Access to the instrument configuration menu may be protected by a four digit security code which must be entered to gain access. New instruments are configured with the default security code 0000 which allows unrestricted access to all configuration functions.

To enter a new security code select $\text{C}\alpha\text{dE}$ from the configuration menu and press P which will cause the Rate Totaliser to display 0000 with one digit flashing. The flashing digit may be adjusted using the \blacktriangledown or \blacktriangle push buttons, when set as required operating the P button will transfer control to the next digit. When all the digits have been adjusted press E to return to the $\text{C}\alpha\text{dE}$ prompt. The revised security code will be activated when the Rate Totaliser is returned to the totalisation mode.

Please contact BEKA associates sales department if the security code is lost.

6.23 Reset configuration to factory defaults

r5Et dEF

This function resets the Rate Totaliser including the lineariser, to the factory default configurations which are shown in section 6.0

To reset the Rate Totaliser to the factory default configurations select r5Et dEF from the configuration menu and press **[P]** which will result in a 0000 display with the first digit flashing. This is a request to confirm the reset to factory default instruction by entering 5urE. Using the **[▼]** or **[▲]** button set the flashing digit to 5 and press **[P]** to transfer control to the second digit which should be set to u. When 5urE has been entered, pressing the **[E]** button will reset the BA337E or BA338E to the factory defaults and return the instrument to the totalising mode.

7. LINEARISER

The BA337E and BA338E Rate Totalisers can produce accurate results when used with a flowmeter having a K-factor that varies with the flow rate, such as a turbine meter used over a wide range of flows. Both models include a sixteen segment straight-line lineariser that may be adjusted to compensate for flowmeter non-linearity.

The lineariser is enabled by selecting $L_i n$ in the $F_u n \bar{L} \bar{E} \bar{I} \bar{O} n$ section of the configuration menu. The configuration menu shown in Fig 10 remains basically unchanged, except that up to 16 values of the flowmeter K-factor can be entered as $L-FR \bar{E} \bar{L} \bar{O} r$, together with $P_u \bar{L} \bar{S} E F_r$ the corresponding input frequency at which each starts.

Fig 12 shows how the Rate Totaliser configuration function $FR \bar{E} \bar{L} \bar{O} r$ is extended when the lineariser is activated by selecting $L_i n$ in the $F_u n \bar{L} \bar{E} \bar{I} \bar{O} n$ menu.

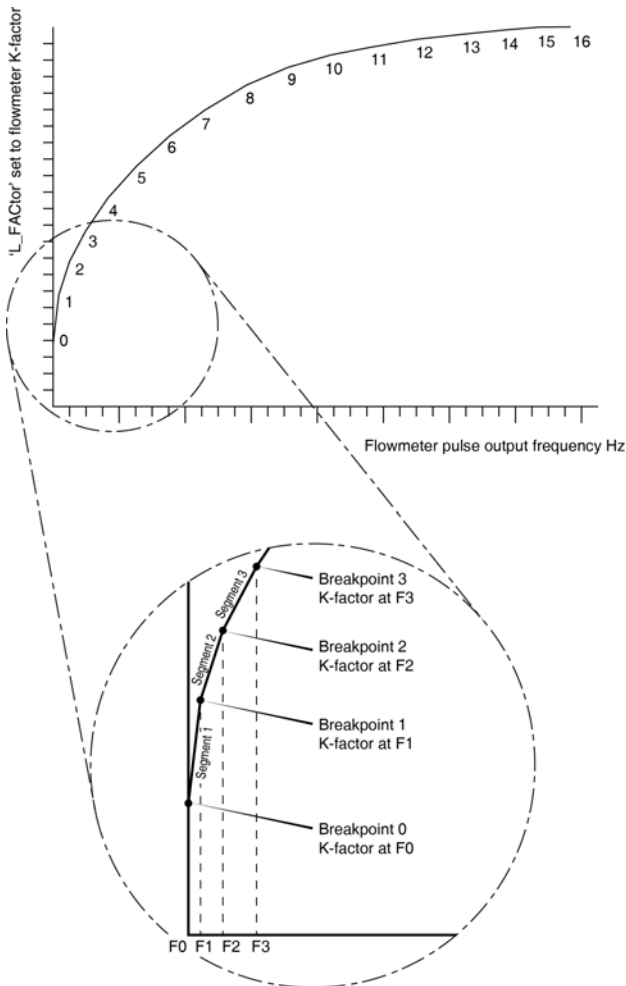

Fig 11 shows a typical linearising characteristic

The lineariser configuration is retained irrespective of how $F_u n \bar{L} \bar{E} \bar{I} \bar{O} n$ in the Rate Totaliser configuration menu is subsequently changed. It is therefore possible to select and deselect the lineariser without having to reconfigure it.

7.1 Flowmeter specification

Flowmeters are usually supplied with a calibration certificate specifying the average K-factor and the flow range over which it applies. For use over extended flow ranges and for non-linear devices, multiple K-factors will be specified, often in a table similar to the one shown below.

Flow Rate Litres/min	K-factor Pulses/litre
5	200
10	230
15	239
20	242

From this calibration certificate information the output frequency of the flowmeter, which is required for conditioning the Rate Totaliser lineariser, can be calculated.

$$\text{Output frequency Hz} = \frac{(\text{Flow rate per min}) \times (\text{K-factor})}{60}$$

Flow Rate Litres/min	K-factor Pulses/litre	Output frequency Hz
0	0	0
5	200	16.666
10	230	38.333
15	239	59.750
20	242	80.666

7.2 Summary of lineariser configuration Functions.

This section summarises the lineariser configuration functions. When read in conjunction with Fig 12 it provides a quick aid for configuring the lineariser. If more detail is required, each section contains a reference to a full description of the function.

The number of straight-line lineariser segments required should first be entered using the $R d d$ and $d \bar{E} \bar{L}$ functions. In both of these sub-functions the Rate Totaliser displays the current segment and the total number of segments being used as shown below.

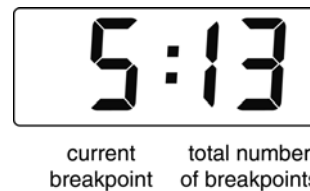

Increasing the number of segments will provide a more accurate approximation of the flowmeter characteristic and increase totalisation accuracy.

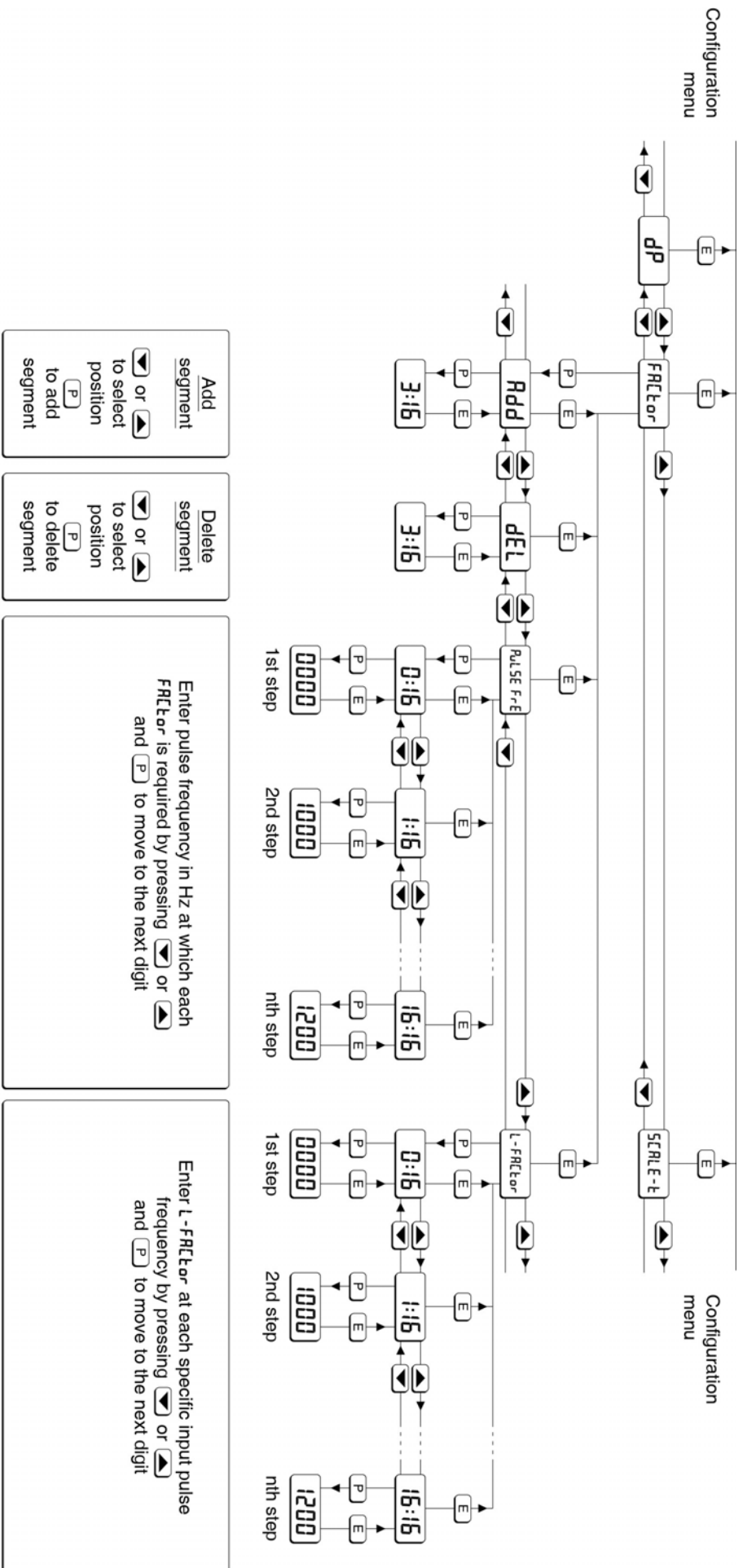

Fig 12 Lineariser configuration menu

For each segment an input pulse frequency in Hz *PuLSE Fr* and a corresponding flowmeter K-factor *L-FRACtor* are required. See section 7.1

Lineariser factory defaults are shown below:

Break point	<i>PuLSEFrE</i>	<i>L-FRACtor</i>
0.1	0Hz	1.00
1.1	5000Hz	1.00

Display Summary of function

- Rdd*** **Add a segment**
 Adds a new segment before the displayed segment. The calibration of existing segments is not changed, but the identification number of all subsequent segments is increased by one.
 See section 7.3

- dEL*** **Remove a segment**
 Removes the displayed segment, the identification number of all subsequent segments is decreased by one.
 See section 7.4

- PuLSE Fr*** **Pulse input frequency**
 Defines the input frequency in Hz at which the selected lineariser segments starts.
 See section 7.5

- L-FRACtor*** **Flowmeter K-factor**
 The rate totaliser pulse input is divided by *L-FRACtor*, which is usually set to the K-factor of the flowmeter, thus converting the flowmeter output into engineering units. *L-FRACtor* may be adjusted between 0.0001 and 99999.
 Up to 16 values for *L-FRACtor* may be entered, each starting at a specified input pulse frequency *PuLSE Fr*.
 See section 7.6

7.3 Add a segment: *Rdd*

Rdd is a sub-menu in the *FRACtor* function that enables a straight-line segment to be added to the lineariser at any point. Select *FRACtor* in the configuration menu and press **[P]**, which will reveal one of four sub-functions. If *Rdd* is not displayed repeatedly press the **[v]** or **[^]** button to select *Rdd* followed by **[P]** which will cause the current segment and the total number of lineariser segments to be displayed as shown below:

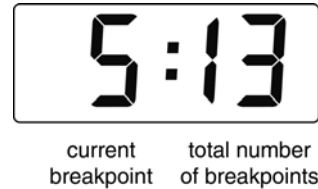

Each time the **[P]** push button is operated a segment will be added to the lineariser. If configuring the lineariser for the first time, repeatedly press **[P]** until the required total number of segments is shown on the right hand side of the display. Any number between 1 and 16 may be selected.

If adding an additional segment to an already configured lineariser, the insertion position, which is shown on the left hand side of the display, can be selected using the **[v]** or **[^]** push button. When inserting an additional segment, the identification numbers of all segments equal to and above the insertion point are increased by one.

Press **[E]** to return to the *Rdd* prompt in the *FRACtor* sub-menu.

7.4 Remove a segment: *dEL*

dEL is a sub-menu in the *FRACtor* function that enables any segment to be removed from the lineariser configuration. Select *FRACtor* in the configuration menu and press **[P]**, which will reveal one of four sub-functions. If *dEL* is not displayed repeatedly press the **[v]** or **[^]** button to select *dEL* followed by **[P]** which will cause the current segment with the total number of segments to be displayed as shown below:

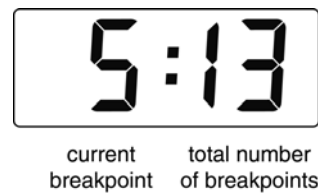

Each time the **[P]** push button is operated the current segment will be deleted from the lineariser. If configuring the lineariser for the first time,

repeatedly press **[P]** until the total number of segments is reduced to the required number.

If removing a segment from a configured lineariser, the segment to be deleted, which is shown on the left hand side of the display, can be selected using the **[▼]** or **[▲]** push button. When a segment is deleted, the identification numbers of all segments above the deleted segment are decreased by one.

Press **[E]** to return to the *dEL* prompt in the lineariser sub-menu.

7.5 Input frequency: *PuLSE Fr*

PuLSE Fr is a sub-menu in the *FRctOr* function for entering the pulse input frequency at which each of the lineariser segments starts, see Fig 12.

To enter the input pulse frequency at which one or more lineariser segments start, select *FRctOr* in the configuration menu and press **[P]** which will reveal one of four sub-functions. If *PuLSE Fr* is not displayed repeatedly press the **[▼]** or **[▲]** button to select *PuLSE Fr* followed by **[P]** to display the current segment for which the start frequency will be entered and the total number of segments that have already been defined using the *Rdd* and *dEL* functions, see below.

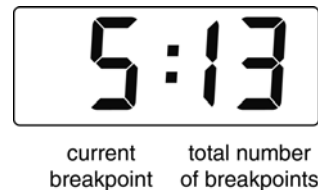

The required segment, which is shown on the left hand side of the display, can be selected using the **[▼]** or **[▲]** push button. When selected press **[P]** which will reveal the current input frequency with one digit flashing. The value of the flashing digit may be changed by pressing the **[▼]** or **[▲]** button. When this digit is correct pressing **[P]** will transfer control to the next digit. When the input frequency for this lineariser segment is set as required, press the **[E]** button to return to the segment identification display from which the next segment may be selected using **[▼]** or **[▲]** push button.

When the input frequency for all of the segments has been entered, return to the *FRctOr* prompt in the configuration menu by operating the **[E]** push button.

7.6 Flowmeter K-factor *L-FRctOr*

L-FRctOr is a sub-menu in the *FRctOr* function for entering the flowmeter K-factor for each of the lineariser segments, see Fig 12.

The rate totaliser pulse input is divided by *L-FRctOr*, which is adjustable between 0.0001 and 99999; for flow applications it should be set to the K-factor of the flowmeter. K-factor is the number of pulses that

the flowmeter produces per unit volume of flow e.g. 20 pulses per litre, $L-FRE\text{t}\text{or}$ therefore converts the flowmeter output into engineering units ready for further scaling to produce the required rate and total flow displays.

To enter the flowmeter K-factor for one or more segments, select $FRE\text{t}\text{or}$ in the configuration menu and press P , which will reveal one of four sub-functions. If $L-FRE\text{t}\text{or}$ is not displayed in the sub-menu repeatedly press the \blacktriangledown or \blacktriangle button to select $L-FRE\text{t}\text{or}$ followed by P to display the current segment for which $L-FRE\text{t}\text{or}$ will be entered and the total number of segments that have already been defined using the Rdd and dEL functions.

The required segment, which is shown on the left hand side of the display, can be selected using the \blacktriangledown or \blacktriangle push button, see below.

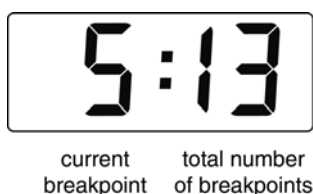

When selected, press P which will reveal the current $L-FRE\text{t}\text{or}$ for the selected segment with one digit flashing. The value of the flashing digit may be changed by pressing the \blacktriangledown or \blacktriangle button. When this digit has been adjusted as required, pressing P will transfer control to the next digit. When all the digits have been adjusted pressing P will transfer control to the decimal point that may be positioned between any of the digits, or may be omitted by moving it to the right of the least significant digit.

When $L-FRE\text{t}\text{or}$ for this lineariser segment is set as required, press the E button to return to the segment identification display from which the next segment may be selected using \blacktriangledown or \blacktriangle push button. When $L-FRE\text{t}\text{or}$ for all of the segments has been entered, return to the $FRE\text{t}\text{or}$ prompt in the configuration menu by operating the E push button twice.

7.7 Lineariser error message

If an attempt is made to position a segment at an input frequency which is not greater than the frequency of the preceding segment, or at an input frequency which is not less than the frequency of the following segment, the error message $URLuEErr$ will be displayed.

8. CONFIGURATION EXAMPLE

In this example a BA337E Rate Totaliser is connected to a turbine flowmeter having a K-factor of 105 pulses per litre with a magnetic pick-off.

The BA337E is required to display rate of flow in imperial gallons per hour with a resolution of one gallon and total flow in cubic metres with a maximum total of 100000 and a resolution of 0.01 cubic metres. Linearisation is not required. Totalisation is to stop when the flow rate falls below 10 gallons per hour. The display is to be updated twice per second.

For this application the operator needs to reset the total display to zero from the totalisation mode, but should not be able to reset the grand total. To prevent tampering the instrument configuration menu is to be protected by security code of 1209

8.1 Configuration procedure

The BA337E Rate Totaliser may be configured on-site without disconnection from the power supply or from the flowmeter.

Step 1 Enter the configuration menu

Enter the configuration menu by simultaneously pressing P and E . Assuming a security code has not already been entered the instrument will respond by displaying $Funct, on$ which is the first function in the configuration menu. See Fig 10.

Step 2 Select a linear function

With $Funct, on$ displayed press P to reveal the function of the Rate Totaliser. Using the \blacktriangledown or \blacktriangle button select $5td$ to switch off the lineariser and provide a linear function. Press E to enter the selection. See 6.4







Step 3 Select the type of input & debounce

Using the \blacktriangledown or \blacktriangle button select $, nP_{ut}$ in the configuration menu and press P which will reveal the sub-menu. Again using the \blacktriangledown or \blacktriangle button select $, nP. tYPE$ and press P to reveal the existing input. The Rate Totaliser is required to work with a magnetic pick-off so using the \blacktriangledown or \blacktriangle button select $[0, L$ followed by E to return to the $, nP. tYPE$ prompt in the sub-menu.







Using the \blacktriangledown or \blacktriangle button select $dEbounEE$ from the sub-menu and press P . Using the \blacktriangledown or \blacktriangle button select $dEFRuLE$ which will provide moderate pulse edge noise protection. If the Rate Totaliser is subsequently found to miscount the noise rejection can be increased. Enter the selection and return to the $, nP_{ut}$ prompt in the configuration menu by pressing the E

button twice.
See 6.6 and 6.7







Step 4 Select the interval between display updates

Using the  or  button select $\mu P d R E$ in the configuration menu and press  to reveal how frequently the Rate Totaliser display is updated. Using the  or  push button select 0.5 (0.5 seconds i.e. 2 display updates per second). Enter the selection and return to the $\mu P d R E$ prompt in the configuration menu by pressing the  button.
See 6.8



Step 5 Upper display





Using the  or  button select $d, 5P-1$ in the configuration menu and press  to select whether flow rate or total flow is shown on the upper 8 digit display. The required maximum total of 100000 with 0.01 resolution can only be accommodated on the top display. Therefore using the  or  button select $t o t R L$ and press  to enter the selection and return to the $d, 5P-1$ prompt in the configuration menu.
See 6.9

Step 6 Lower display

Using the  or  button select $d, 5P-2$ in the configuration menu and press  which will show if the lower display is $o n$ or $o f f$. The Rate Totaliser is required to display both total flow and the rate of flow so the lower display is required. Using the  or  button select $o n$ and press  to enter the selection and return to the $d, 5P-2$ prompt in the configuration menu.
See 6.10

Step 7 Position rate & total decimal points

Select $d P$ from the configuration menu and press . The upper display already defined as the total display by function $d, 5P-1$ will be activated and identified by the Total annunciator. Using the  or  push button position the decimal point in front of the second least significant digit to give a total display resolution of 0.00.

Pressing the  button will show the rate display, but in the upper display position with the Rate annunciator activated. Using the  or  push button position the decimal point to the right of the least significant digit so that it is not visible to give a total display resolution of 1. Finally press the  button to enter the selections and return to the $d P$ prompt in the configuration menu.
See 6.11

Step 8 Enter the flowmeter K-factor

K-factor is the number of pulses that a flowmeter produces per unit volume of flow. The Rate Totaliser pulse input is divided by FRC_{Factor} , which is adjustable between 0.0001 and 99999. When set to the K-factor of the flowmeter FRC_{Factor} converts the flowmeter output into engineering units ready for further scaling to produce the required rate and total flow displays.

Using the \blacktriangledown or \blacktriangle push button select FRC_{Factor} from the configuration menu and press P to show the existing value with one digit flashing. Enter 4.5461 using the \blacktriangledown or \blacktriangle push button to adjust the flashing digit and the P button to transfer control to the next digit and to position the decimal point. Finally return to the FRC_{Factor} prompt in the configuration menu by pressing E . The output from FRC_{Factor} will now be in litres which may be scaled to produce required rate and total displays. See 6.12

Step 9 Enter the total scale factor

The Total Scale Factor $SCALE_{\text{t}}$ is a dividing factor adjustable between 0.0001 and 99999 that enables total flow to be displayed in the required engineering units. In this example the total flow display is required in cubic metres. There are 1,000 litres in a cubic metre so $SCALE_{\text{t}}$ should be set to 1000.

Using the \blacktriangledown or \blacktriangle push button select $SCALE_{\text{t}}$ from the configuration menu and press P to reveal the existing value with one digit flashing. Enter 1000 using the \blacktriangledown or \blacktriangle push button to adjust the flashing digit and the P button to transfer control to the next digit and to position the decimal point. Finally, return to the $SCALE_{\text{t}}$ prompt in the configuration menu by pressing E . The total flow display is independent of the rate display. See 6.13

Step 10 Enter the rate scale factor

$SCALE_{\text{r}}$ is a dividing factor adjustable between 0.0001 and 99999 that enables the flow rate to be displayed in the required engineering units. The rate display timebase is determined by t_{base} that is adjusted in Step 11.

In this example the rate of flow display is required in imperial gallons. FRC_{Factor} , which was adjusted in Step 8 of this example produces an output in Litres that must be converted to imperial gallons. There are 4.5461 Litres in an imperial gallon so $SCALE_{\text{r}}$ should be adjusted to 4.5461

Using the \blacktriangledown or \blacktriangle push button select $SCALE_{\text{r}}$ from the configuration menu and press P to reveal the existing value with one digit flashing. Enter 4.5461 using the \blacktriangledown or \blacktriangle push button to adjust the flashing digit and the P button to transfer control to the next digit and to position the decimal point. Finally return to the $SCALE_{\text{r}}$ prompt in the configuration menu by pressing E . The flow rate display is independent of the total flow display. See 6.14

Step 11 Enter the rate timebase

The rate timebase determines whether flow rate is displayed per second, per minute or per hour. In this example gallons per hour are required.



Using the \blacktriangledown or \blacktriangle push button select t_{base} from the configuration menu and press P . Again using the \blacktriangledown or \blacktriangle push button select 3600 from the three options which will multiply the rate display by 3600. Return to the t_{base} prompt in the configuration menu by pressing E . See 6.15





Step 12 Adjust the display filter

The digital display filter has two independent adjustable parameters enabling the rate display response to be tailored for optimum performance. The filter parameters are controlled by a two digit number. The first digit defines the amount of filtering applied to the display, for initial configuration it is recommended it is set to 2 which is a time constant of 4.3 seconds. The second digit controls jump-out following a step input change and it is recommended that this is initially set to 0.

After configuration during commissioning both parameters should be adjusted experimentally to provide a stable display with an acceptable step response.

To allow the effect of filter changes to be seen immediately, the live rate display is shown on the lower display while the filter parameters are shown and may be adjusted on the upper display.







Using the  or  push button select *FILTEr* from the configuration menu and press .

The first digit, which controls the filter time constant, will be flashing and should be set to 2 using the  or  push button. The  button will transfer control to the second digit, which controls the step response and should be set to 0 in the same way. When entered return to the *FILTEr* prompt in the configuration menu by pressing .

See 6.16

Step 13 Define clip-off

To prevent totalisation of low flow rates clip-off defines a flow rate threshold below which totalisation is inhibited. In this example it is required that totalisation does not occur at flow rates below 10 gallons per hour.









Using the  or  push button select *CLP OFF* from the configuration menu. Press  which will reveal the current clip-off threshold in gallons per hour i.e. the same units already selected for the rate display. Enter 10 using the  or  push button to adjust the flashing digit and the  button to transfer control to the next digit. Finally, store the new clip-off threshold and return to the *CLP OFF* prompt in the configuration menu by pressing .







See 6.17

Step 14 Local reset of total and grand total

Two separate functions in the *LoC CLR* sub-menu may be individually activated to enable the operator to reset the total and grand total displays from the totalisation mode without entering the configuration menu.









In this example the operator is required to be able to reset the total display but not the grand total display when the BA337E Rate Totaliser is in the totalisation mode.

Using the  or  button select *LoC CLR* in the configuration menu and press  which will reveal the sub-menu. Again using the  or  button select the local total reset function *CLR tot* and press . This function is required so using the  or  button select *on* followed by  to return to the *CLR tot* prompt in the sub-menu.

Using the  or  button select the local grand total reset function *CLR GRt* and press . This function is not required so using the  or  button select *OFF*. Finally return to the *LoC CLR* prompt in the configuration menu by pressing the  button twice.

See 6.18, 6.19 and 6.20.







Step 15 Reset the grand total to zero

Before completing configuration the Rate Totaliser's grand total should be reset to zero. Using the  or  button select *CLR GRt* in the configuration menu and press  which will cause *CLR GRt* to be displayed with *no* flashing. Again using the  or  button select *CLR GRt* with *GRt* flashing. Press  which will result in *0000* being displayed with one digit flashing. This is a request for the instruction to be confirmed by entering *SURE* using the  or  button to set each digit and the  button to move control to the next digit.

Pressing  will then reset the grand total to zero and return the instrument to the *CLR GRt* prompt in the configuration menu.

See 6.21.

Step 16 Define the security code

Defining a security code prevents unauthorised access to the configuration menu. Using the  or  buttons select *SecE* from the configuration menu and press  which will result in *0000* being displayed with the first digit flashing. This example requires the security code to be 1209, using the  or  buttons set the flashing digit to 1 and press  to transfer control to the second digit. When all the digits of the new code have been entered press  to store the code and return to the main configuration menu.

See 6.22.

Step 17 Return to the totalisation mode

Configuration of the BA337E is now complete. Pressing the  button will save the new configuration and return the Rate Totaliser to the totalisation mode. The BA337E will display *RRR* followed by *SRUE* while the new information is being stored in permanent memory.

9. MAINTENANCE

9.1 Fault finding during commissioning

If a BA337E or a BA338E fails to function during commissioning the following procedure should be followed:

Symptom	Cause	Check:
No display	No power supply, or incorrect wiring. Note: Terminals 2, 6 & RS2 are interconnected within the instrument.	That there is between 10 and 28V on terminals 1 & 2 with terminal 1 positive.
Rate Totaliser is receiving power but flow indicator not rotating	No input pulses, incorrect input configuration, incorrect linking of terminals 3 & 4	Input configuration. Linking of terminals 3 & 4. That input signal polarity is correct.
Flow indicator rotating but incorrect rate display	Incorrect rate display calibration	FRÉÉ or SCRLÉ.r É-bRSE
Flow indicator rotating but incorrect total display	Incorrect total display calibration. Remote reset switch contacts closed	FRÉÉ or SCRLÉ.É That RESET annunciator is not activated. If it is, check reset wiring and switch.
Flow indicator rotating, but zero rate display, no totalisation and HOLD annunciator activated.	CLP OFF is activated	CLP OFF and if necessary adjust threshold.
Unstable rate display	Noisy pulse input signal	Eliminate source of electrical noise. Increase debounce and/or display filter.
Unable to enter configuration menu.	Incorrect security code	That the correct security code is being used. Contact BEKA if code is lost.
Clip-off does not function	Clip-off has automatically reset to zero following change of rate display calibration.	Reconfigure CLP OFF
Alarms do not function	Alarms have been disabled following calibration change	Re-enable both alarms.

9.2 Fault finding after commissioning

ENSURE PLANT SAFETY BEFORE STARTING MAINTENANCE

Live maintenance is permitted on intrinsically safe equipment installed in a hazardous area, but only certified test equipment should be used unless a gas clearance certificate is available.

If a BA337E or a BA338E fails after it has been functioning correctly, the following table may help to identify the cause of the failure.

Symptom	Cause	Check:
No display	No power supply.	That there is between 10 and 28V on terminals 1 & 2
Flow indicator not rotating	No input pulses	Output from flowmeter. Wiring between flowmeter and Rate Totaliser.
Flow indicator rotating, rate display is zero and totalisation. HOLD annunciator is not activated.	Input below clip-off threshold.	CLP OFF threshold and if necessary adjust.
Unstable rate display	Noisy pulse input signal	Locate source of electrical noise, or increase debounce and rate display filter.

If this procedure does not reveal the cause of the fault, it is recommended that the instrument is replaced.

9.3 Servicing

We recommend that faulty BA337E and BA338E rate totalisers are returned to BEKA associates or to our local agent for repair.

9.4 Routine maintenance

The mechanical and electrical condition of the instrument should be regularly checked. Initially annual inspections are recommended, but the inspection frequency should be adjusted to suit the environmental conditions.

9.5 Guarantee

Instruments which fail within the guarantee period should be returned to BEKA associates or our local agent. It is helpful if a brief description of the fault symptoms is provided.

9.6 Customer comments

BEKA associates is always pleased to receive comments from customers about our products and services. All communications are acknowledged and whenever possible, suggestions are implemented.

10. ACCESSORIES

Accessories for the two models differ as shown below, all except the scale card, are factory fitted and should be specified when the instrument is ordered:

BA337E 96 x 48mm	BA338E 144 x 72mm
Scale card	Scale card
Tag number	Tag number
Backlight ¹	Backlight ¹
Isolated dual alarms ² or Isolated 4/20mA output ² or Isolated pulse output ²	Isolated dual alarms Isolated 4/20mA output See note 3

Notes:

1. Internally powered
2. Only one of the three output options may be fitted to a BA337E.
3. All BA338E Rate Totalisers are fitted with an isolated pulse output.

10.1 Scale card

Both models have a window on the right hand side of the display through which to view a scale card showing the units of measurement such as Gals/hour or Litres. New Rate Totalisers are fitted with a scale card showing the units of measurement specified when the instrument was ordered, if the units are not specified a blank scale card will be fitted. A pack of scale cards pre-printed with common units of measurement is available as an accessory. These can easily be fitted on-site to the Rate Totaliser without opening the instrument enclosure or removing it from the panel, See section 5.4 of this instruction manual.

Custom scale cards for applications requiring less common units of measurement are also available.

10.2 Tag information

Both models can be supplied with a tag number or application information thermally printed onto the rear panel adjacent to the terminals. This information is not visible from the front of the instrument after installation.

10.3 Backlight

The BA337E and the BA338E Rate Totalisers can be supplied with a factory fitted backlight that produce green illumination enhancing display contrast and enabling it to be read at night or in poor lighting conditions. Both the BA337E and BA338E backlights are internally powered from the instrument power supply so that no additional wiring or intrinsically safe interface is required, but the instrument supply current increases.

	Current consumption	
	BA337E	BA338E
Without backlight		10.0mA
10.0mA		
Addition for backlight	22.5mA	16.0mA
Addition with terminals 3 & 4 linked	6.0mA	6.0mA
Total current	38.5mA	32.0mA

10.4 Alarms

The BA337E and BA338E can be supplied with factory fitted dual solid state single pole alarm outputs that may be independently programmed as high or low, rate or total alarms with normally open or normally closed outputs. Only one output option can be fitted to a BA337E.

Configurable functions for each alarm include adjustable setpoint, alarm delay time and alarm silence time. Hysteresis may be applied to rate alarms.

CAUTION

Alarm outputs should not be used for critical safety applications such as a shut down system.

When the BA337E or BA338E power supply is turned off or disconnected, alarm outputs will open irrespective of whether normally open or normally closed outputs have been selected. When designing a system an open output should therefore be chosen for the alarm condition.

Alarm annunciators on the instrument display indicate the status of each alarm. If an alarm delay or silence time has been selected the annunciator will flash during the delay or silence period.

The BA337E and BA338E internal counters are updated and compared with the alarm setpoint twice per second, irrespective of the display update time selected. This may result in an alarm being delayed for up to half a second after the rate or total has exceeded the setpoint.

10.4.1 Solid state output

Each alarm has a galvanically isolated single pole solid state switch output as shown in Fig 13. The outputs are polarised and current will only flow in one direction. Terminals A1 and A3 should be connected to the positive side of the supply.

$$\begin{aligned} R_{on} &= \text{less than } 5\Omega + 0.7V \\ R_{off} &= \text{greater than } 1M\Omega \end{aligned}$$

Note: Because of the series protection diode some test meters may not detect a closed alarm output.

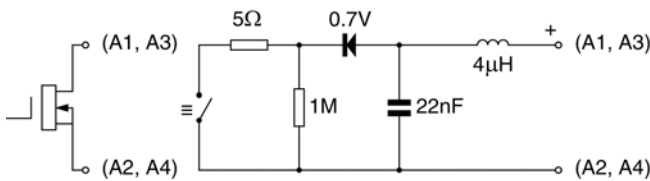

Fig 13 Equivalent circuit of each alarm output

10.4.2 Intrinsic safety

Each alarm output is a separate galvanically isolated intrinsically safe circuit with output safety parameters complying with the requirements for *simple apparatus*. This allows the alarm output terminals A1 & A2 and A3 & A4 to be connected to almost any intrinsically safe circuit protected by a Zener barrier or galvanic isolator providing the output parameters of the circuit do not exceed:

$$\begin{aligned} U_o &\leq 28V \text{ dc} \\ I_o &\leq 200mA \text{ dc} \\ P_o &\leq 0.84W \end{aligned}$$

The maximum equivalent capacitance and inductance between each set of alarm terminals is:

$$\begin{aligned} C_i &= 22nF \\ L_i &= 4\mu H \end{aligned}$$

To determine the maximum permissible cable parameters C_i should be subtracted from the maximum permitted external capacitance C_o specified by the certificate for the intrinsically safe interface powering the alarm circuit, such as the solenoid driver and switch transfer galvanic isolators shown in Fig 14.

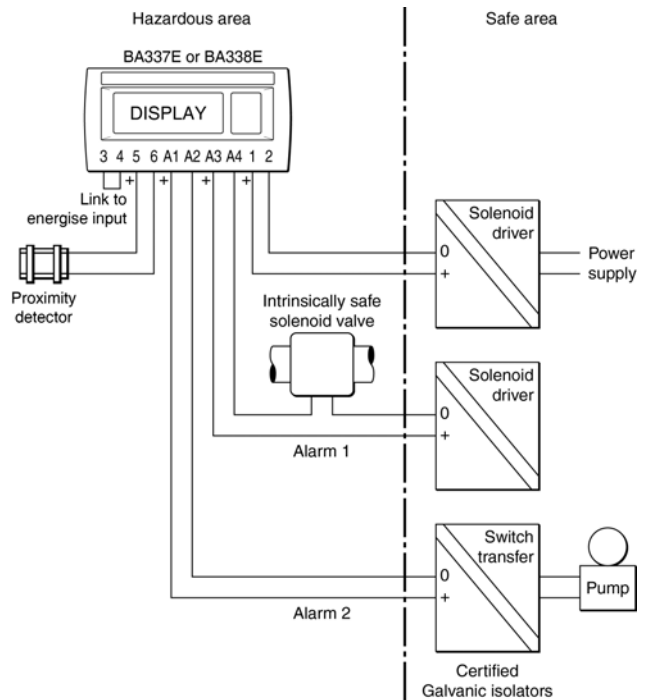

Fig 14 Typical alarm application

10.4.3 Configuration and adjustment

When a BA337E or BA338E is supplied with alarms the configuration menu is extended as shown in Fig 15. The alarm functions appear after $\llcorner \llcorner \llcorner \llcorner$, and each alarm may be configured to operate on the rate or total display.

For simplicity Fig 15 only shows the configurable functions on the rate option of alarm AL1, the total options is identical except that total alarms do not have hysteresis. Alarm AL2 is identical to alarm AL1.

The following table summarises each of the alarm configuration functions and includes a cross reference to more detailed information. Again only the functions on alarm AL1 are listed.

Display	Summary of function
EnbL	Alarm enable Enables or disables the alarm without changing the alarm parameters. See section 10.4.4
ŁYPE	Type of alarm Defines whether the alarm operates on the rate or total display. See section 10.4.5
SP 1r or SP 1Ł	Alarm setpoint 1 Adjusts the alarm setpoint. The alarm is activated when the rate or total display equals the setpoint. Note: <i>SP 1r</i> is displayed for a rate alarm and <i>SP 1Ł</i> for a total alarm. See section 10.4.6
H.LŁ	Alarm function Defines whether the alarm has a high or low function. See section 10.4.7
no.nŁ	Normally open or normally closed output. Determines whether the single pole alarm output is open or closed in the non-alarm condition. See section 10.4.8
HŁŁr	Hysteresis Adjusts the alarm hysteresis. Only available on a rate alarm. See section 10.4.9
dELR	Alarm delay time Adjusts the delay between the display equaling the setpoint and the alarm output being activated. See section 10.4.10
S.L	Alarm silence time Defines the time that the alarm output remains in the non-alarm condition following acceptance of an alarm. See section 10.4.11
FLSH	Flash display when alarm occurs When enabled, alternates the rate or total display between process value and alarm reference <i>RL 1</i> or <i>RL 2</i> when an alarm output is activated. See section 10.4.12
RLSP	Access setpoint Sub-menu that enables direct access to the alarm setpoints from the totalisation mode and defines a separate security code. See section 10.4.13

10.4.4 Alarm enable: EnbL

This function allows the alarm to be enabled or disabled without altering any of the alarm parameters. Using the \blacktriangledown or \blacktriangle push button select *RL 1* or *RL 2* from the configuration menu and press P to access the alarm sub-menu. Press the \blacktriangledown or \blacktriangle button until *EnbL* is displayed followed by P which will reveal if the function is *on* or *off*. The setting can be changed by pressing the \blacktriangledown or \blacktriangle push button followed by the E button to return to the alarm sub-menu.

10.4.5 Type of alarm: ŁYPE

Alarm 1 and Alarm 2 are totally independent, both may be rate or total alarms, or one may be conditioned for rate and the other for total.

Using the \blacktriangledown or \blacktriangle push button select *ŁYPE* from the selected alarm sub-menu and press P to check or change the function. The \blacktriangledown or \blacktriangle push button will toggle the selection between *rŁŁŁ* and *ŁŁŁŁ*, when set as required press the E button to return to the alarm sub-menu.

Note: When *ŁYPE* is changed, the alarm configuration is automatically reset to the default values and the alarm is disabled. It must therefore be reconfigured before use.

10.4.6 Setpoint adjustment: SP 1x & SP 2x

The rate alarm setpoints *SP 1r* and *SP 2r* may be positioned anywhere between 000000 and 999999 and the total alarm setpoint *SP 1Ł* and *SP 2Ł* anywhere between 00000000 and 99999999.

All the setpoints are adjusted in the same way, for example to adjust the setpoint of Alarm 1 which has been configured to operate on the rate display. Using the \blacktriangledown or \blacktriangle push button select *SP 1r* in the *RL 1* sub-menu and press P which will reveal the existing setpoint with one digit flashing. The required setpoint can be entered using the \blacktriangledown or \blacktriangle push button to adjust the flashing digit and the P button to transfer control to the next digit. When set as required press E to enter the value and return to the *SP 1r* prompt in the alarm 1 sub-menu.

10.4.7 Alarm function: H.LŁ

Alarm 1 and Alarm 2 are totally independent, both may be *H*, or *L*, or one may be conditioned as a *H* alarm and the other as a *L* alarm.

Using the \blacktriangledown or \blacktriangle push button select *H.LŁ* from the selected alarm sub-menu and press P to check or change the function. The \blacktriangledown or \blacktriangle push button will toggle the alarm function between *H* and *L*, when set as required, press the E button to return to the *H.LŁ* prompt in the alarm sub-menu.

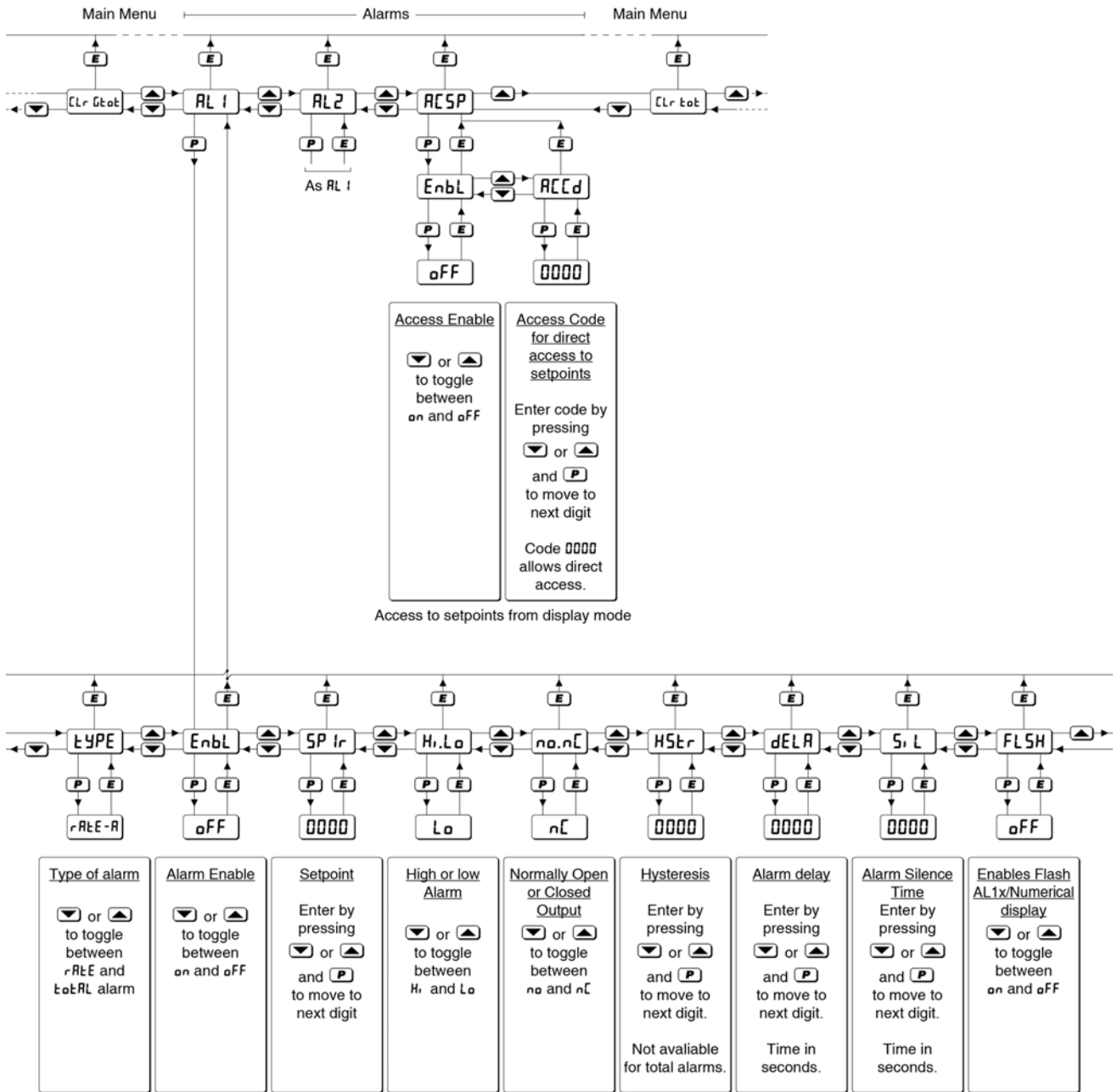

Fig 15 Alarm menu structure

10.4.8 Alarm output status: $no.n\bar{c}$

Each single pole alarm output may be open or closed in the non-alarm condition. When the BA337E or BA338E power supply is turned off or disconnected, the alarm output(s) will open irrespective of whether normally open or normally closed outputs have been selected. Therefore when designing an alarm system normally closed $n\bar{c}$ should be selected so that the output opens when an alarm occurs or if the power supply fails.

Using the \blacktriangledown or \blacktriangleleft push button select $no.n\bar{c}$ from the selected alarm sub-menu and press P to check or change the function. The \blacktriangledown or \blacktriangleleft push button will toggle the contact status between no and $n\bar{c}$, when set as required, press the E button to return to the $no.n\bar{c}$ prompt in the alarm sub-menu.

10.4.9 Hysteresis: $H5\bar{t}r$

Hysteresis is only available on rate alarms so the $H5\bar{t}r$ function only appears in the configuration sub-menu when alarm $TYPE$ has been set to $rate$. During configuration hysteresis is shown in the units of rate previously configured for the rate display.

Using the \blacktriangledown or \blacktriangleleft push button select $H5\bar{t}r$ in the selected alarm sub-menu and press P which will reveal the existing hysteresis with one digit flashing. The required hysteresis can be entered using the \blacktriangledown or \blacktriangleleft push button to adjust the flashing digit and the P button to transfer control to the next digit. When set as required press E to enter the value and return to the $H5\bar{t}r$ prompt in the alarm sub-menu.

e.g. A Rate Totaliser configured to display a flow of 0 to 5000, with a high alarm set at 4000 and hysteresis of 100 will perform as follows:

High alarm will be activated when flow equals or exceeds 4000, but will not reset until the flow falls below 3900.

10.4.10 Alarm delay: $dELR$

This function enables activation of the alarm output to be delayed for a fixed time following the alarm condition occurring. The delay can be set in 1 second increments up to 3600 seconds. If a delay is not required zero should be entered.

To adjust the delay select $dELR$ using the \blacktriangledown or \blacktriangleleft push button in the selected alarm sub-menu and press P which will reveal the existing delay time in seconds with one digit flashing. The required delay time can be entered using the \blacktriangledown or \blacktriangleleft push button to adjust the flashing digit and the P button to transfer control to the next digit. When set as required press E to enter the value and return to the $dELR$ prompt in the alarm sub-menu.

The Rate Totaliser's alarm annunciator will start flashing immediately an alarm condition occurs and will continue for the delay time, after which the alarm output will be activated and the alarm annunciator will be permanently activated.

10.4.11 Alarm silence time: $5, L$

The alarm silence function is primarily intended for use in small installations where the alarm output directly operates an annunciator such as a sounder. When the alarm silence time is set to any figure other than zero, the P push button becomes an alarm accept button.

After an alarm has occurred, operating the P button will cause the alarm output to revert to the non-alarm condition for the programmed alarm silence time. When an alarm is silenced by operating the P push button, the Rate Totaliser's alarm annunciator will flash until the silence time expires.

To adjust the alarm silence time select $5, L$ using the \blacktriangledown or \blacktriangleleft push button in the selected alarm sub-menu and press P which will reveal the existing alarm silence time in seconds with one digit flashing. The required silence time can be entered using the \blacktriangledown or \blacktriangleleft push button to adjust the flashing digit and the P button to transfer control to the next digit. When set as required press E to enter the value and return to the $5, L$ prompt in the alarm sub-menu.

10.4.12 Flash display when alarm occurs: $FL5H$

In addition to the two alarm annunciators on the left hand side of the Rate Totaliser display which show the status of both alarms, this function provides an even more conspicuous indication that an alarm condition has occurred.

When enabled, this function alternates the rate or total display between the numerical value and the alarm identification $RL1$ or $RL2$ when an alarm occurs.

Using the \blacktriangledown or \blacktriangleleft push button select $FL5H$ from the selected alarm sub-menu and press P to check or change the function. The \blacktriangledown or \blacktriangleleft push button will toggle the function between off and on , when set as required, press the E button to return to the $FL5H$ prompt in the alarm sub-menu.

10.4.13 Access Setpoint: $ACSP$

This function activates a separate menu that provides direct access to the alarm setpoints from the totalisation mode by simultaneously operating the P and \blacktriangleleft buttons. An operator can therefore adjust the alarm setpoints without having access to the configuration and alarm sub-menus. Protection against unauthorised or accidental adjustment is provided by a separate security access code.

Using the \blacktriangledown or \blacktriangle push button select $RESP$ from the configuration menu and press P to reach the enable function $ENBL$. Pressing P will reveal the existing setting which can be toggled between ON and OFF by pressing the \blacktriangledown or \blacktriangle push button. When set as required, press the E button to return to the $ENBL$ prompt from which a separate security access code can be entered using the $REED$ function which can be selected using the \blacktriangledown or \blacktriangle push button.

To enter a new security code select $REED$ from the $RESP$ sub-menu and press P which will cause the Rate Totaliser to display 0000 with one digit flashing. The flashing digit may be adjusted using the \blacktriangledown or \blacktriangle push button, when set as required operating the P button will transfer control to the next digit. When all the digits have been adjusted press E twice to return to the $RESP$ prompt in the configuration menu. The revised security code will be activated when the Rate Totaliser is returned to the totalisation mode. Default security access code 0000 will disable the security code allowing direct access to the setpoints from the totalisation mode by pressing the P and \blacktriangle buttons simultaneously.

Please contact BEKA associates sales department if the security code is lost.

10.4.14 Adjusting alarm setpoints from the totalisation mode

Access to the two alarm setpoints from the Rate Totaliser totalisation mode is obtained by operating the P and \blacktriangle push buttons simultaneously as shown in Fig 16. If the setpoints are not protected by a security code the alarm setpoint prompt $SP1x$ or $SP2x$ will be displayed depending upon whether a rate or total alarm has been conditioned. If access to the setpoints is protected by a security code, $Code$ will be displayed first. Pressing P again will allow the alarm setpoint security code to be entered digit by digit using the \blacktriangledown or \blacktriangle button to change the flashing digit and the P push button to move control to the next digit. If the correct code is entered pressing E will result in the alarm setpoint prompt $SP1x$ to be displayed. If an incorrect security code is entered, or a button is not pressed within ten seconds, the instrument will automatically return to the totalisation mode.

Once within the menu pressing the \blacktriangledown or \blacktriangle buttons will toggle the display between the two alarm setpoint prompts $SP1x$ and $SP2x$.

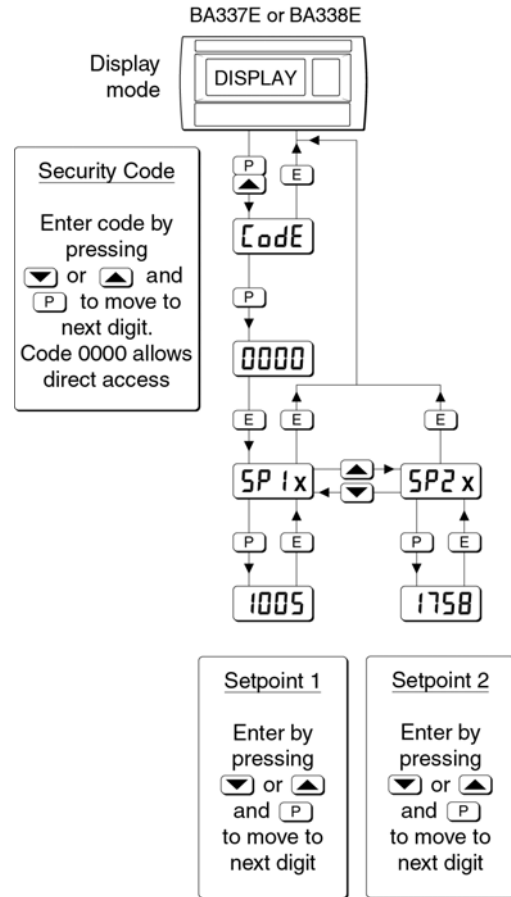

Fig 16 Setpoint adjustment from the totalisation mode

To adjust an alarm setpoint select $SP1x$ or $SP2x$ and press P which will reveal the existing value. The flashing digit of the setpoint may be adjusted using the \blacktriangledown or \blacktriangle push button and the P button to move control to the next digit. When the required setpoint has been entered, pressing E will return the display to the $SP1x$ or $SP2x$ prompt from which the other setpoint may be selected, or the instrument may be returned to the totalisation mode by pressing E again.

Note: Direct access to the alarm setpoints is only available when the menu is enabled - see section 10.4.13

10.5 Pulse output

All BA338E Rate Totalisers are supplied with an opto-isolated pulse output. The pulse output is available as a factory fitted option on the smaller BA337E Rate Totaliser, but only one output option can be fitted to this model.

The pulse output is an open collector having the following parameters:

R _{on}	=	60Ω + 3V
R _{off}	=	1M
I _{max}	=	10mA

The output pulse may be a duplicate of the input pulse for re-transmission applications, or it may be derived from the least significant digit of the total display. When derived from the total display the output pulse frequency may be divided and the output pulse width defined.

The retransmitted RTx annunciator on the instrument display shows the status of the retransmitted pulse output. Annunciator activation depends upon the setting of *SOURCE* in the pulse output configuration menu.

SCALEd

Annunciator activated each time pulse output open collector is on, i.e. R_{on} is less than 60Ω + 3V.

direct

Annunciator continuously activated

10.5.1 Intrinsic safety

The pulse output is an optically isolated separate intrinsically safe circuit that has zero output safety parameters. The output therefore complies with the requirements for *simple apparatus*. This allows pulse output terminals P1 and P2 to be connected to any intrinsically safe circuit protected by a certified Zener barrier or galvanic isolator providing the output parameters do not exceed:

U _o	≤	28V dc
I _o	≤	200mA dc
P _o	≤	0.84W

The equivalent capacitance and inductance of the pulse output are both zero which allows the maximum permissible cable parameters specified by the certificate for the Zener barrier or galvanic isolator powering the pulse output circuit to be used.

10.5.2 System design

The Rate Totalisers pulse output is a passive circuit i.e. not powered, but it is totally isolated from all other Rate Totaliser circuits. Subject to complying with intrinsic safety interconnection requirements, the terminals P1 and P2 may be connected to another

instrument with an open collector input. The pulse output may also be transferred to the safe area via a galvanic isolator or a Zener barrier.

Fig 17 shows how a 2-channel Zener barrier may be used to produce a voltage pulse in the safe area that could be used to drive a safe area counter. The positive terminal of the pulse output circuit P1 is connected to the Rate totaliser's positive supply terminal 1. When an output pulse occurs and the open collector output 'closes', P2 is connected to P1 and the pulse current flows through the diode return barrier to resistor R1 in the safe area. The current flowing in the circuit is determined by R1 which should be chosen to limit the pulse output current to less than 10mA. For a 24V supply R1 should be greater than 2,200Ω.

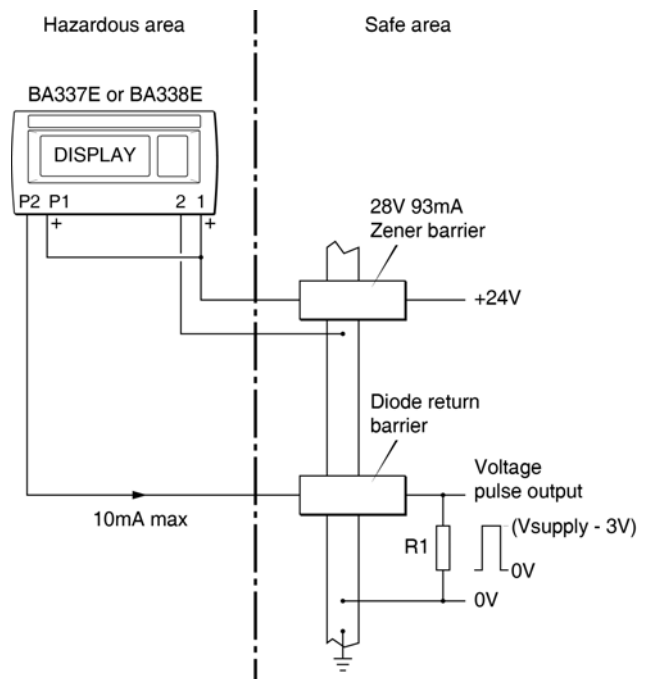

Fig 17 Transferring pulse output to the safe area using Zener barriers

10.5.3 Configuration

All BA338E Rate Totalisers are supplied with an opto-isolated pulse output, the pulse output is also available as a factory fitted option on the smaller BA337E. Therefore the pulse output menu shown in Fig 18 appears in the configuration menu of all BA338E Rate Totalisers, but only in the configuration menu of BA337E Rate Totalisers having an optional factory fitted pulse output.

The pulse output sub-menu enables the source of the output pulse to be selected in the *SOURCE* sub-function. For re-transmission applications the output pulse may be a duplicate of the input pulse by selecting *direct* in the *SOURCE* sub-function. Alternatively, selecting *SCALEd* derives the output

pulse from incrementation of the least significant digit of the total display. When *5CRLEd* is selected two additional functions, *d, U, dE* and *durAtion* are added to the sub-menu allowing the output pulse frequency to be divided and the output pulse width (duration) to be defined.

10.5.4 Pulse output: PuLSE oP

The pulse output is configured in a sub-menu which is accessed via the *PuLSE oP* function which is included in all BA338E configuration menus and in BA337E configuration menus when the optional pulse output option is fitted.

Using the \blacktriangledown or \blacktriangle push button scroll though the configuration menu until *PuLSE oP* is displayed, pressing **P** will then access the pulse output sub-menu which is shown in Fig 18.

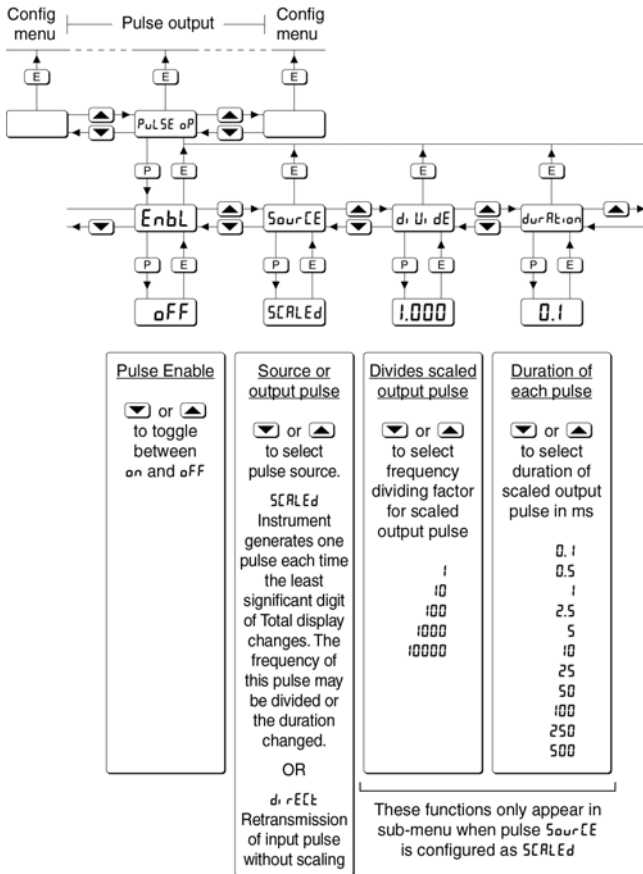

Fig 18 Pulse output configuration sub-menu

10.5.5 Enable pulse output: EnbL

This function allows the pulse output to be enabled or disabled without altering any of the pulse output parameters. Using the \blacktriangledown or \blacktriangle push button select *EnbL* in the pulse output sub-menu and press **P** which will reveal the existing setting *on* or *oFF*. The function can be changed by pressing the \blacktriangledown or \blacktriangle push button followed by the **E** button to return to *EnbL* prompt in the sub-menu.

10.5.6 Source of output pulse: 5ourCE

The output pulse may be derived from:

- 5CRLEd* Incrementation of least significant digit of the total display. May be divided and width defined by the *d, U, dE* and *durAtion* functions to generate the required output pulse.
- d, rECt* Output is synchronous duplicate of the Rate Totaliser input pulse.

Using the \blacktriangledown or \blacktriangle push button select *5ourCE* in the pulse output sub-menu and press **P** to reveal the existing pulse source. The function can be changed by pressing the \blacktriangledown or \blacktriangle push button followed by the **E** button to return to *5ourCE* prompt in the sub-menu.

10.5.7 Divide output pulse frequency: d, U, dE

When *5CRLEd* is selected in the *5ourCE* sub-function (10.5.6) the output pulse is derived from incrementation of the least significant digit of the total display divided by one of the following five factors to produce the output pulse:

- 1
- 10
- 100
- 1000
- 10000

Using the \blacktriangledown or \blacktriangle push button select *d, U, dE* in the pulse output sub-menu and press **P** which will reveal the existing divisor. The selected divisor can be changed by pressing the \blacktriangledown or \blacktriangle push button followed by the **E** button to return to *d, U, dE* prompt in the sub-menu.

Note: This function only appears in the pulse output sub-menu when the *5CRLEd* is selected in the *5ourCE* sub-function (10.5.6).

10.5.8 Output pulse width: durAtion

When *5CRLEd* is selected in the *5ourCE* sub-function (10.5.6) the output pulse width is defined by this function. One of following millisecond pulse widths may be selected:

- 0.1
- 0.5
- 1
- 2.5
- 5
- 10
- 25
- 50
- 100
- 250
- 500

Using the \blacktriangledown or \blacktriangleleft push button select $d_{ur}Rt, on$ in the pulse output sub-menu and press P which will reveal the existing pulse duration. The value can be changed by pressing the \blacktriangledown or \blacktriangleleft push button to select the required value followed by the E button to return to $d_{ur}Rt, on$ prompt in the sub-menu.

Note: This function only appears in the pulse output sub-menu when $5rLEd$ is selected in the $5_{our}EE$ sub-function (10.5.6).

10.5.9 Pulse storage

If the $d_i U_i dE$ and $d_{ur}Rt, on$ functions are configured such that the output pulse frequency with the specified pulse width can not be output in real time, the number of pulses will be stored and transmitted at the maximum possible speed.

When the total display is reset to zero or the power supply to the Rate Totaliser is disconnected or turned off, any stored pulses will not be retained.

10.6 4/20mA output

Both the BA337E and BA338E Rate Totalisers can be supplied with a factory fitted galvanically isolated 4/20mA output which may be configured to represent the rate or total display. Only one output option can be fitted to a BA337E.

10.6.1 Intrinsic safety

The 4/20mA output has been certified as a separate galvanically isolated intrinsically safe circuit complying with the requirements for *simple apparatus*. This allows terminals C1 and C3 to be connected to any intrinsically safe circuit protected by a certified Zener barrier or galvanic isolator providing the output parameters do not exceed:

$$\begin{aligned} U_o &\leq 28\text{V dc} \\ I_o &\leq 200\text{mA dc} \\ P_o &\leq 0.84\text{W} \end{aligned}$$

The maximum equivalent capacitance and inductance of the 4/20mA output output is:

$$\begin{aligned} C_i &= 2.2\text{nF} \\ L_i &= 4\mu\text{H} \end{aligned}$$

To determine the maximum permissible cable parameters, these figures should be subtracted from the maximum cable capacitance and inductance specified by the certificate for the Zener barrier or galvanic isolator powering the 4/20mA output circuit.

10.6.2 System design

The Rate Totalisers 4/20mA output is a galvanically isolated passive current sink i.e. not powered, but it is totally isolated from all other Rate Totaliser circuits. It is effectively a 2-wire 4/20mA transmitter requiring a minimum supply of 10V with its current being controlled by the Rate Totaliser. Subject to complying with intrinsic safety interconnection requirements, the terminals C1 and C3 may be connected to another instrument, which will accept a 4/20mA transmitter input. The 4/20mA current output may also be transferred to the safe area via a galvanic isolator or Zener barriers. Terminals C2 and C4 are internally linked and may be used for joining a return 4/20mA wire.

Fig 19 shows how a 2-channel Zener barrier may be used to transfer the 4/20mA current output into the safe area, alternatively a galvanic isolator may be used.

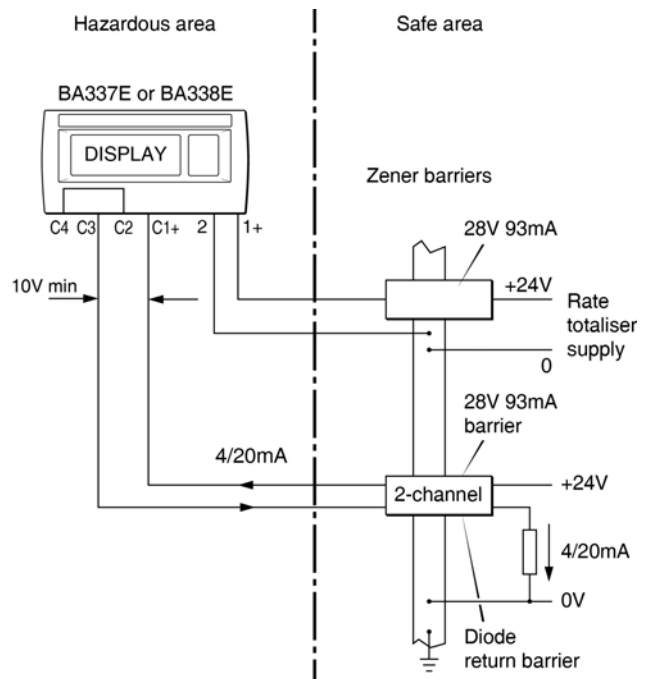

Fig 19 Application of 4/20mA output

10.6.3 Configuration

When a Rate Totaliser is supplied with an optional 4/20mA output the configuration menu is extended as shown in Fig 20. The 4/20mA output sub-menu is accessed via the $4-20\text{ mA}$ function.

The 4/20mA output sub-menu allows the 4/20mA output to be controlled by the rate or the total display and to be scaled.

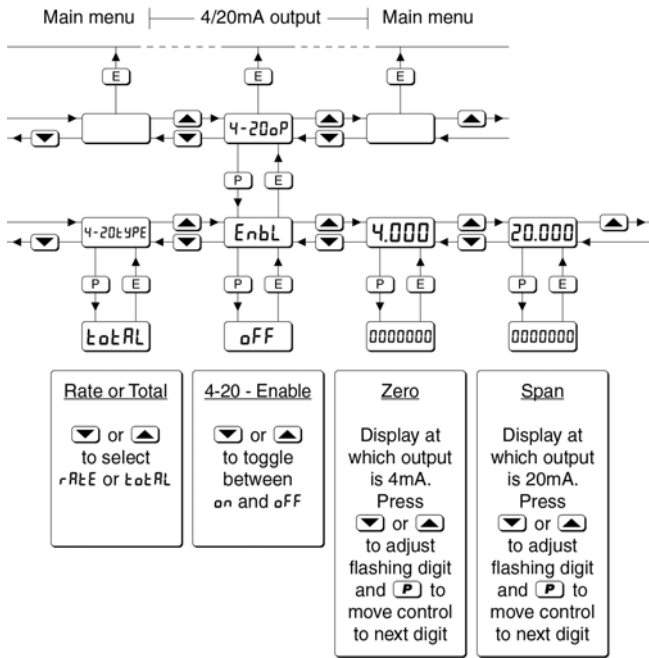

Fig 20 4/20mA output configuration sub-menu

10.6.4 4/20mA output: 4-20 oP

Access the Rate Totaliser's configuration menu as described in section 6.2. Using the \blacktriangledown or \blacktriangle push buttons scroll through the menu until **4-20 oP** is displayed, pressing **P** will then access the 4/20mA output sub-menu which is shown in Fig 20.

10.6.5 Enable 4/20mA output: EnbL

This function allows the 4/20mA current output to be disabled or enabled without altering the calibration. Using the \blacktriangledown or \blacktriangle push button select **EnbL** in the **4-20 oP** sub-menu and press **P** to reveal the existing setting **on** or **oFF**. The function can be changed by pressing the \blacktriangledown or \blacktriangle push button followed by the **E** button to return to **EnbL** prompt in the sub-menu.

10.6.6 Select rate or total source: 4-20tYPE

The 4/20mA output current can represent the Rate Totaliser's rate or total display, this should be defined before any other current output functions are adjusted.

Using the \blacktriangledown or \blacktriangle push button select **4-20tYPE** in the 4/20mA output sub-menu and press **P** to reveal the existing setting **tOtRL** or **rRtE**. The function can be changed by pressing the \blacktriangledown or \blacktriangle push button followed by the **E** button to return to the **4-20tYPE** prompt in the sub-menu.

10.6.7 Display which corresponds to 4mA output: 4.000

The Rate Totaliser display which corresponds to a 4.000mA output current is defined by this function. Using the \blacktriangledown or \blacktriangle push button select **4.000** in the 4/20mA output sub-menu and press **P** which will reveal the existing rate or total display with one digit flashing. The required display can be entered using the \blacktriangledown or \blacktriangle push button to adjust the flashing digit and the **P** button to transfer control to the next digit. When set as required press **E** to enter the value and return to the **4.000** prompt in the 4/20mA output sub-menu.

10.6.8 Display which corresponds to 20mA output: 20.000

The Rate Totaliser display which corresponds to a 20.000mA output current is defined by this function. Using the \blacktriangledown or \blacktriangle push button select **20.000** in the 4/20mA output sub-menu and press **P** which will reveal the existing rate or total display with one digit flashing. The required display can be entered using the \blacktriangledown or \blacktriangle push button to adjust the flashing digit and the **P** button to transfer control to the next digit. When set as required press **E** to enter the value and return to the **20.000** prompt in the 4/20mA output sub-menu.

Notes:

- If the calibration of the rate or total display defined as the source for the 4/20mA output is changed, the 4/20mA output will automatically be set to give a constant 3.5mA output irrespective of the display. The 4/20mA output should always be reconfigured following reconfiguration of the source display.
- If the Rate Totaliser and the 4/20mA current sink output are powered from separate supplies, the 4/20mA output current will continue to flow when the Rate Totaliser supply fails or is turned off. Powering both from a common supply eliminates this effect.

Appendix 1 IECEx certification

A1.0 The IECEx Certification Scheme

IECEx is a global certification scheme for explosion protected products which aims to harmonise international certification standards. For additional information about the IECEx certification scheme and to view the BEKA associate certificates, please visit www.iecex.com

A1.1 IECEx Certificate of Conformity

The BA337E and the BA338E Rate Totalisers have been issued with an IECEx Certificate of Conformity number IECEx ITS 16.0004X which specifying the following certification code:

Ex ia IIC T5 Ga -40°C ≤ Ta ≤ +70°C.

The IECEx certificate may be downloaded from www.beka.co.uk, www.iecex.com or requested from the BEKA sales office.

A1.2 Installation

The IECEx intrinsic safety parameters are identical to the ATEX safety parameters described in the main section of this manual and both refer to the same standards. Therefore the ATEX installation requirements specified in section 3, 4 and 5 of this manual may be used for IECEx installations, but the local code of practice should also be consulted.

A1.3 Special conditions for safe use

The IECEx certificate has an 'X' suffix indicating that special conditions apply to prevent an electrostatic charge developing on the outside of the instrument enclosure.

WARNING

To avoid an electrostatic charge being generated instrument enclosure should only be cleaned with a damp cloth.

Appendix 2 ETL & cETL certification for installations in USA and Canada

A2.0 cETL Mark

For installations in the USA and Canada, the BA337E and the BA338E Rate Totalisers have ETL and cETL intrinsic safety and nonincendive approval, Control Number 4008610. Copies of the Authorisation to Mark are available from the BEKA associates sales office and www.beka.co.uk

A2.1 Intrinsic safety approval

The US and Canadian standards used for assessment and certification of the BA337E and BA338E are listed on the cETL Authorisation to Mark.

Installations must comply with BEKA associates Control Drawing CI330-52, which is attached to this appendix.

The ETL safety parameters are the same as the ATEX and IECEx parameters, the systems shown in sections 3 and 4 of this manual may therefore also be used for US and Canadian installations subject to compliance with the local codes of practice.

ETL and cETL intrinsic safety codes

CL I Div 1 Groups A, B, C, D T5 (US IS gas, Div cert)
CL II Div 1 Groups E, F, G. CL III (US IS dust, Div cert)

CL I Zone 0 AEx ia IIC T5 Ga (US IS gas, Zone cert)
Ex ia IIC T5 Ga (Canadian IS gas, Zone cert)

$-40^{\circ}\text{C} \leq T_a \leq 70^{\circ}\text{C}$

A2.2 Nonincendive approval

The BA337E and BA338E Rate Totalisers also have ETL nonincendive approval allowing installation in Division 2 hazardous (classified) locations without the need for Zener barriers or galvanic isolators.

Installations must comply with BEKA associates Control Drawing CI330-53, which is attached to this appendix, and with the local codes of practice.

ETL and cETL nonincendive codes US & Canada

CL I Div 2 Groups A, B, C, D T5
CL II Div 2 Groups F, G CL III Div 2
 $-40^{\circ}\text{C} \leq T_a \leq 70^{\circ}\text{C}$

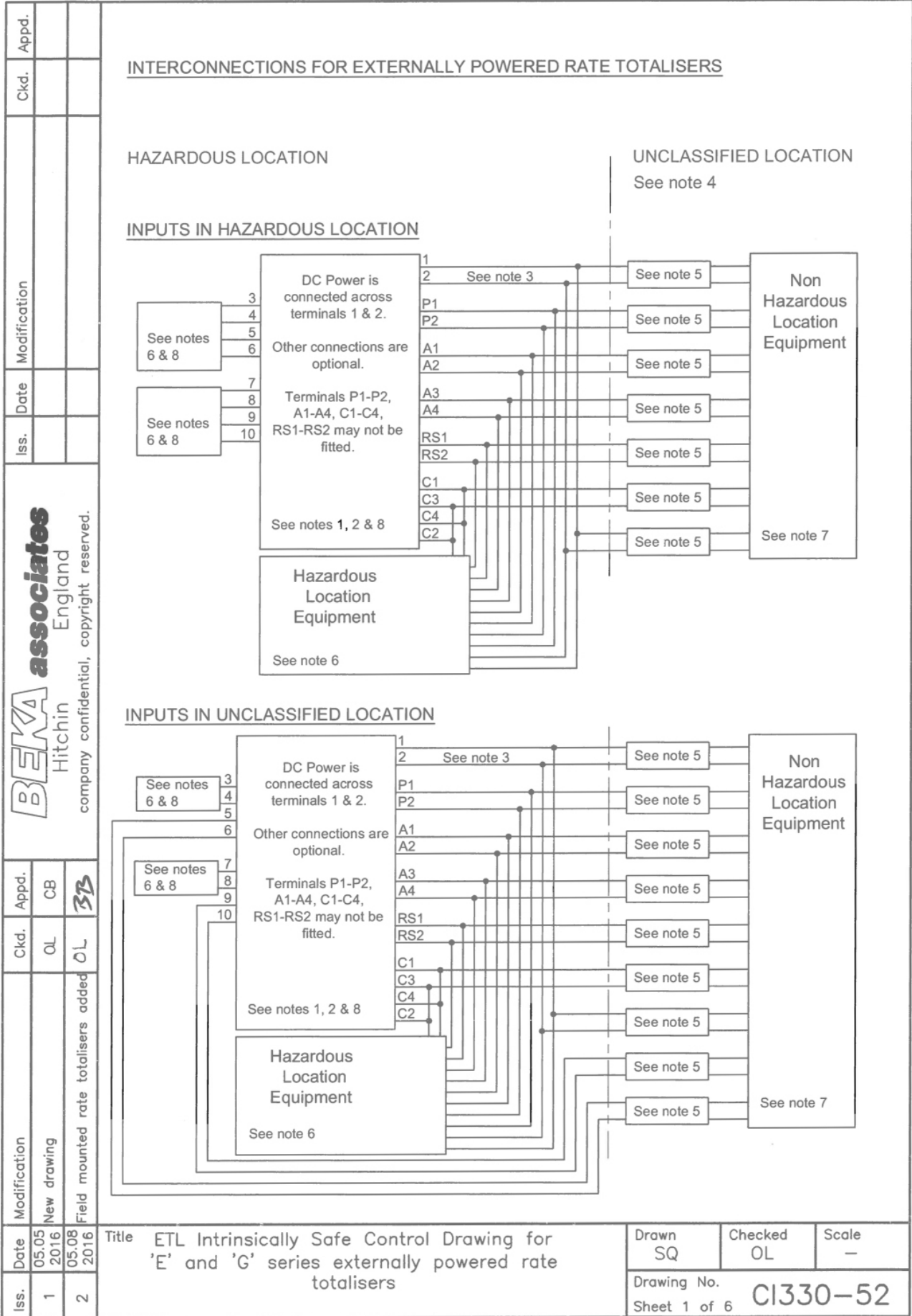

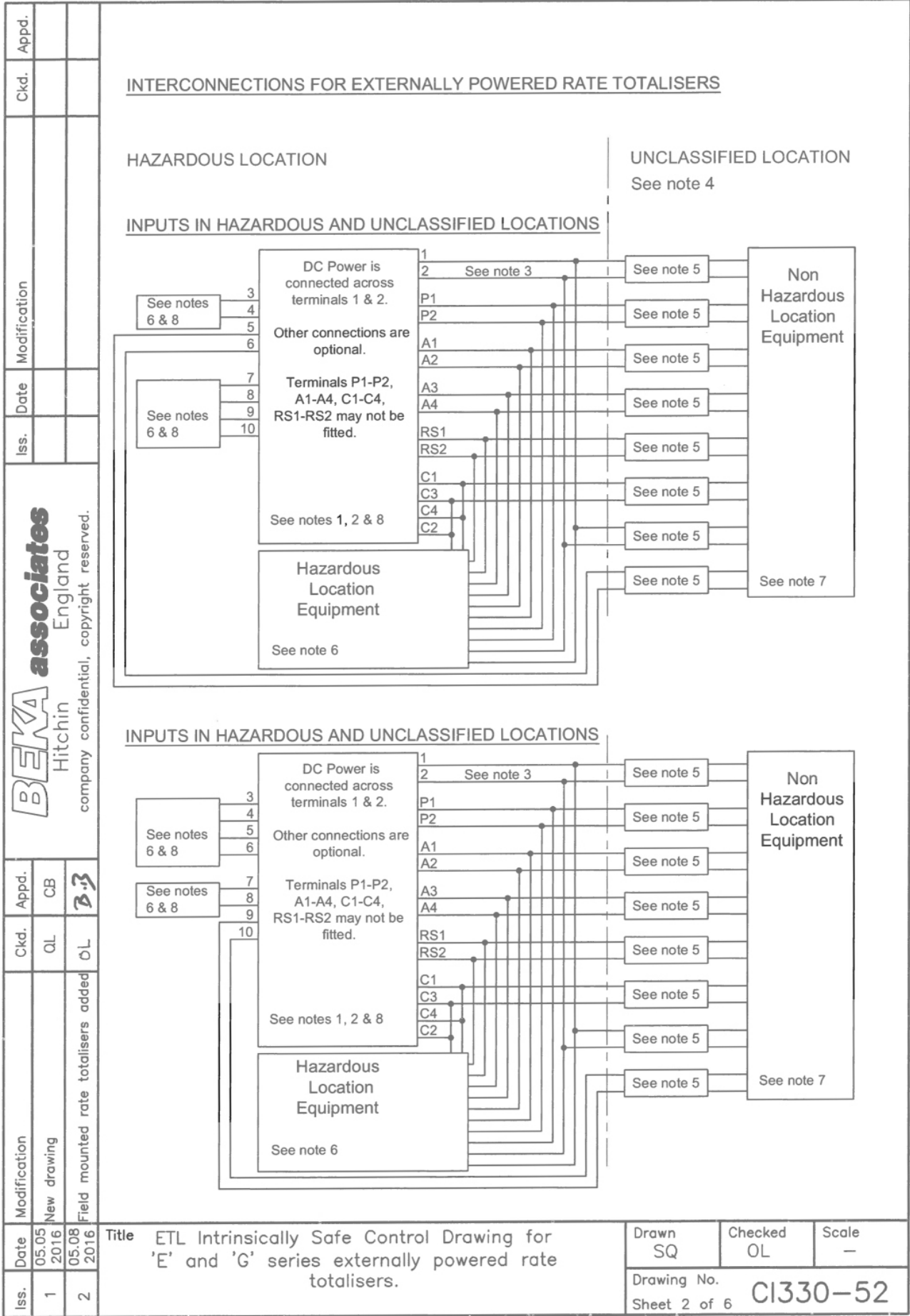

Iss.	1	Appd.	OL	Appd.		Notes 1. 1 and 2 input externally powered rate totalisers with model numbers and coding as shown in the following tables.					
Iss.	2	Appd.	OL	Appd.							
Modification		Modification		Modification							
Date		Date		Date							
Iss.		Iss.		Iss.							
<div style="display: flex; justify-content: space-between; align-items: center;"> <div style="writing-mode: vertical-rl; transform: rotate(180deg);"> <p>BEKA associates Hitchin England company confidential, copyright reserved.</p> </div> <div style="text-align: right;"> <p>1. 1 and 2 input externally powered rate totalisers with model numbers and coding as shown in the following tables.</p> </div> </div>											
E PANEL MOUNTING INSTRUMENTS											
Type		Model Nos.		Division Marking		Zonal Marking		Ambient Temp.			
1 input tachometer 1 input rate totaliser 2 input rate totaliser 1 input counter 2 input counter 1 input timer 2 input timer		BA317E BA318E BA337E BA338E BA388E BA367E BA368E BA377E BA378E		Class I Division 1 Groups A, B, C & D T5 Class II Division 1 Groups E, F & G Class III Division 1		Zone 0 AEx ia IIC T5 Ga		-40°C to +70°C			
E-SS PANEL MOUNTING INSTRUMENTS											
Type		Model Nos.		Division Marking		Zonal Marking		Ambient Temp. (see note 9)			
1 input tachometer 1 input rate totaliser 1 input counter 1 input timer		BA317E-SS BA337E-SS BA367E-SS BA377E-SS		Class I Division 1 Groups A, B, C & D T5 Class II Division 1 Groups E, F & G Class III Division 1		Zone 0 AEx ia IIC T5 Ga Zone 20 AEx ia IIC T80°C Da		-40°C to +60°C			
G FIELD MOUNTING INSTRUMENTS											
Type		Model Nos.		Division Marking		Zonal Marking		Ambient Temp. (see note 9)			
1 input tachometer 1 input rate totaliser 2 input rate totaliser 2 input counter 2 input timer		BA314G BA334G BA384G BA364G BA374G		Class I Division 1 Groups A, B, C & D T5 Class II Division 1 Groups E, F & G Class III Division 1		Zone 0 AEx ia IIC T5 Ga Zone 20 AEx ia IIC T80°C Da		-40°C to +60°C			
E FIELD MOUNTING INSTRUMENTS											
Type		Model Nos.		Division Marking		Zonal Marking		Ambient Temp.			
1 input tachometer 1 input rate totaliser 2 input rate totaliser 2 input counter 2 input timer		BA314E BA334E BA384E BA364E BA374E		Class I Division 1 Groups A, B, C & D T5 Class II Division 1 Groups E, F & G Class III Division 1		Zone 0 AEx ia IIC T5 Ga		-40°C to +70°C			
2. Terminals 7, 8, 9 and 10 only exist on 2 input instruments.											
Date	05.05.2016	Appd.	OL	Appd.		Drawn	SQ	Checked	OL	Scale	-
Date	05.08.2016	Appd.	OL	Appd.		Drawing No.			C1330-52		
Iss.	1	Appd.	OL	Appd.		Sheet 3 of 6					
Modification	New drawing	Appd.	OL	Appd.							
Modification	Field mounted rate totalisers added	Appd.	OL	Appd.							
Title	ETL Intrinsically Safe Control Drawing for 'E' and 'G' series externally powered rate totalisers.					Drawn	SQ	Checked	OL	Scale	-

Iss.		Date		Modification		Ckd.		Appd.			
1		05.05 2016		New drawing		OL					
2		05.08 2016		Field mounted rate totalisers added		OL		BB			
				<p>3. Installations shall be in accordance with ANSI/ISA RP 12.06.01 'Installation of Intrinsically Safe Systems for Hazardous (Classified) Locations' and the National Electrical Code ANSI/NFPA 70. Installations in Canada shall be in accordance with the Canadian Electrical Code C22.2.</p> <p>4. The associated protective barriers and galvanic isolators shall be NRTL approved and the manufacturers instructions shall be followed when installing this equipment. For installations in Canada the associated protective barriers and galvanic isolators shall be NRTL or CSA approved and the manufacturers installation drawings shall be followed when installing this equipment.</p> <p>5. One single channel or one two channel associated protective barrier or galvanic isolator with entity parameters complying with the following requirements:</p> <p>Uo equal or less than the lowest Ui of the NRTL or CSA approved apparatus installed in the loop.</p> <p>Io equal or less than the lowest li of the NRTL or CSA approved apparatus installed in the loop.</p> <p>Po equal or less than the lowest Pi of the NRTL or CSA approved apparatus installed in the loop.</p> <p>Lo equal or greater than the sum of the cable inductances and the internal inductances Li of each NRTL or CSA approved apparatus in the loop.</p> <p>Co equal or greater than the sum of the cable capacitance and the internal capacitance Ci of each NRTL or CSA approved apparatus in the loop.</p> <p>6. Simple Apparatus as defined in the National Electrical Code ANSI/NFPA 70, or for installations in Canada by the Canadian Electrical Code C22.2 OR:</p> <p>Ui equal or greater than the highest Uo of the NRTL or CSA approved apparatus powering the loop.</p> <p>li equal or greater than the highest lo of the NRTL or CSA approved apparatus powering the loop.</p> <p>Pi equal or greater than the highest Po of the NRTL or CSA approved apparatus powering the loop.</p> <p>Lo of the NRTL or CSA approved apparatus powering the loop equal or greater than the sum of the cable inductances and the internal inductances Li of each NRTL or CSA approved apparatus in the loop.</p> <p>Co of the NRTL or CSA approved apparatus powering the loop equal or greater than the sum of the cable capacitances and the internal capacitances Ci of each NRTL or CSA approved apparatus in the loop.</p>							
Title				ETL Intrinsically Safe Control Drawing for 'E' and 'G' series externally powered rate totalisers.		Drawn		Checked		Scale	
						SQ		OL		-	
						Drawing No.		CI330-52			
						Sheet 4 of 6					

Iss.	Date	Modification	Ckd.	Appd.	Iss.	Date	Modification	Ckd.	Appd.	<p>7. The unclassified location equipment shall not use or generate more than 250V rms or 250V dc.</p> <p>8. Safety parameters</p> <p>DC Power terminals 1 & 2</p> <table style="margin-left: 40px;"> <tr><td>Ui</td><td>=</td><td>28V</td><td>Uo = 0</td></tr> <tr><td>Ii</td><td>=</td><td>200mA</td><td>Io = 0</td></tr> <tr><td>Pi</td><td>=</td><td>0.84W</td><td></td></tr> <tr><td>ci</td><td>=</td><td>2nF</td><td></td></tr> <tr><td>Li</td><td>=</td><td>4μH</td><td></td></tr> </table> <p>Terminals 4,5,6 (input A for models in notes 6 and 7), terminals 8,9,10 (input b for models in note 7).</p> <table style="margin-left: 40px;"> <tr><td>Ui</td><td>=</td><td>28V</td><td>Uo = 1.1V</td></tr> <tr><td>Ii</td><td>=</td><td>200mA</td><td>Io = 0.5mA</td></tr> <tr><td>Pi</td><td>=</td><td>0.84W</td><td>Po = 0.2mW</td></tr> <tr><td>ci</td><td>=</td><td>2nF</td><td></td></tr> <tr><td>Li</td><td>=</td><td>4μH</td><td></td></tr> </table> <p>Optional pulse output terminals P1 & P2</p> <table style="margin-left: 40px;"> <tr><td>Ui</td><td>=</td><td>28V</td><td>Uo = 0</td></tr> <tr><td>Ii</td><td>=</td><td>200mA</td><td>Io = 0</td></tr> <tr><td>Pi</td><td>=</td><td>0.84W</td><td></td></tr> <tr><td>ci</td><td>=</td><td>0</td><td></td></tr> <tr><td>Li</td><td>=</td><td>0</td><td></td></tr> </table> <p>Optional alarm output terminals A1, A2, A3 and A4</p> <table style="margin-left: 40px;"> <tr><td>Ui</td><td>=</td><td>28V</td><td>Uo = 1.47V</td></tr> <tr><td>Ii</td><td>=</td><td>200mA</td><td>Io = 1μA</td></tr> <tr><td>Pi</td><td>=</td><td>0.84W</td><td>Po = 2μW</td></tr> <tr><td>ci</td><td>=</td><td>22nF</td><td></td></tr> <tr><td>Li</td><td>=</td><td>4μH</td><td></td></tr> </table>	Ui	=	28V	Uo = 0	Ii	=	200mA	Io = 0	Pi	=	0.84W		ci	=	2nF		Li	=	4μH		Ui	=	28V	Uo = 1.1V	Ii	=	200mA	Io = 0.5mA	Pi	=	0.84W	Po = 0.2mW	ci	=	2nF		Li	=	4μH		Ui	=	28V	Uo = 0	Ii	=	200mA	Io = 0	Pi	=	0.84W		ci	=	0		Li	=	0		Ui	=	28V	Uo = 1.47V	Ii	=	200mA	Io = 1μA	Pi	=	0.84W	Po = 2μW	ci	=	22nF		Li	=	4μH	
											Ui	=	28V	Uo = 0																																																																												
Ii	=	200mA	Io = 0																																																																																							
Pi	=	0.84W																																																																																								
ci	=	2nF																																																																																								
Li	=	4μH																																																																																								
Ui	=	28V	Uo = 1.1V																																																																																							
Ii	=	200mA	Io = 0.5mA																																																																																							
Pi	=	0.84W	Po = 0.2mW																																																																																							
ci	=	2nF																																																																																								
Li	=	4μH																																																																																								
Ui	=	28V	Uo = 0																																																																																							
Ii	=	200mA	Io = 0																																																																																							
Pi	=	0.84W																																																																																								
ci	=	0																																																																																								
Li	=	0																																																																																								
Ui	=	28V	Uo = 1.47V																																																																																							
Ii	=	200mA	Io = 1μA																																																																																							
Pi	=	0.84W	Po = 2μW																																																																																							
ci	=	22nF																																																																																								
Li	=	4μH																																																																																								
1	05.05 2016	New drawing	OL		2	05.08 2016	Field mounted rate totalisers added	DL																																																																																		

BEKA associates
Hitchin
England
company confidential, copyright reserved.

Terminals RS1-RS2, (optional reset input)	
Ui = 28V	Uo = 3.8V
Ii = 200mA	Io = 1mA
Pi = 0.84W	Po = 1mW
ci = 0	
Li = 0	

Terminal 3,4,5,6 (input A for models in notes 6 and 7), terminals 7,8,9,10 (input b for models in note 7).

Ui	=	14V	Uo = 10.5V
Ii	=	200mA	Io = 9.2mA
Pi	=	0.7W	Po = 24mW
ci	=	2nF	
Li	=	4μH	

Optional 4-20mA output terminals C1, C2, C3 and C4

Ui	=	28V	Uo = 0
Ii	=	200mA	Io = 0
Pi	=	0.84W	
ci	=	2.2nF	
Li	=	4μH	

Iss.	Date	Modification	Ckd.	Appd.	Iss.	Date	Modification	Ckd.	Appd.	<p>10. CAUTION Aluminium and stainless steel certification labels that are mounted on the BA317E, BA318E, BA337E, BA338E, BA367E, BA368E, BA377E, BA378E and BA388E externally powered rate totaliser enclosures may be marked with their maximum capacitance (8pF). The BA317E, BA318E, BA337E, BA338E, BA367E, BA368E, BA377E, BA378E and BA388E enclosures may also carry the following potential electrostatic warning:</p> <p style="text-align: center;">WARNING</p> <p style="text-align: center;">Potential electrostatic charging hazard clean only with a damp cloth</p> <p style="text-align: center;">AVERTISSEMENT</p> <p style="text-align: center;">Risque potentiel de charge électrostatique Nettoyer uniquement avec un chiffon humide</p> <p>Alternatively, the enclosures may be manufactured from a conducting plastic per Article 250 of the National Electrical Code.</p>						
											<p>11. When mounting the BA317E, BA318E, BA337E, BA338E, BA367E, BA368E, BA377E, BA378E and the BA388E panel mounting externally powered rate totalisers in an enclosure to maintain Type 4 front panel rating:</p> <p style="margin-left: 40px;">Minimum panel thickness should be 2mm (0.08inches) Steel 3mm (0.12inches) Aluminium</p> <p style="margin-left: 40px;">Outside panel finish should be smooth, free from particles, inclusions, runs or build-ups around cut-out.</p> <p style="margin-left: 40px;">Panel cut-out for BA317E, BA327E, BS367E and BA377E shall be: 90.0 x 43.5mm -0.0 +0.5mm (3.54 x 1.71 inches -0.00 +0.02)</p> <p style="margin-left: 40px;">Two panel mounting clips are required and each shall be tightened to between: 20 & 22cNm (1.77 to 1.95inLb)</p> <p style="margin-left: 40px;">Panel cut-out for BA318E, BA338E, BA368E, BA378E and BA388E shall be: 66.2 x 136.0mm-0.0 +0.5mm (2.60 x 5.35 inches -0.00 +0.02)</p> <p style="margin-left: 40px;">Four panel mounting clips are required and each shall be tightened to between: 20 & 22cNm (1.77 to 1.95inLb)</p>					
Iss.	Date	Modification	Ckd.	Appd.	Iss.	Date	Modification	Ckd.	Appd.	<p>12. When mounting the BA317E-SS, BA337E-SS, BA367E-SS, and BA377E-SS panel mounting externally powered rate totalisers in an AEx e, AEx n, AEx p or AEx t certified enclosure, or an enclosure to maintain IP66 front panel rating, the panel cut-out shall be:</p> <p style="margin-left: 40px;">92.0 +0.8/-0.0 x 45.0 +0.6/-0.0mm (3.62 +0.03/-0.0 x 1.77 +0.02/-0.0 inches)</p> <p style="margin-left: 40px;">4 panel mounting clamps are required and each shall be tightened to a minimum of 22cNm (1.95inLb).</p> <p style="margin-left: 40px;">When correctly installed, the BA317E-SS, BA337E-SS, BA367E-SS and BA377E-SS will not invalidate the certification of an AEx e, AEx n, AEx p or AEx t panel enclosure.</p>						
											<p>ETL Intrinsically Safe Control Drawing for 'E' and 'G' series externally powered rate totalisers.</p>					
1	05.05 2016	New drawing	QL	CB	3.3					<table border="1" style="width: 100%;"> <tr> <td>Drawn SQ</td> <td>Checked OL</td> <td>Scale -</td> </tr> <tr> <td colspan="2">Drawing No. Sheet 6 of 6</td> <td style="font-size: 1.2em; font-weight: bold;">CI330-52</td> </tr> </table>	Drawn SQ	Checked OL	Scale -	Drawing No. Sheet 6 of 6		CI330-52
Drawn SQ	Checked OL	Scale -														
Drawing No. Sheet 6 of 6		CI330-52														
2	05.08 2016	Field mounted rate totalisers added	OL													

Iss.	1	Date	15.06.2016	Modification	New drawing	Ckd.	QL	Appd.	CB
Iss.	2	Date	05.08.2016	Modification	Field mounted rate totalisers added	Ckd.	OL	Appd.	33

BEKA associates
Hitчин
England
company confidential, copyright reserved.

INTERCONNECTIONS FOR EXTERNALLY POWERED RATE TOTALISERS

HAZARDOUS LOCATION

UNCLASSIFIED LOCATION
See note 4

INPUTS IN HAZARDOUS LOCATION

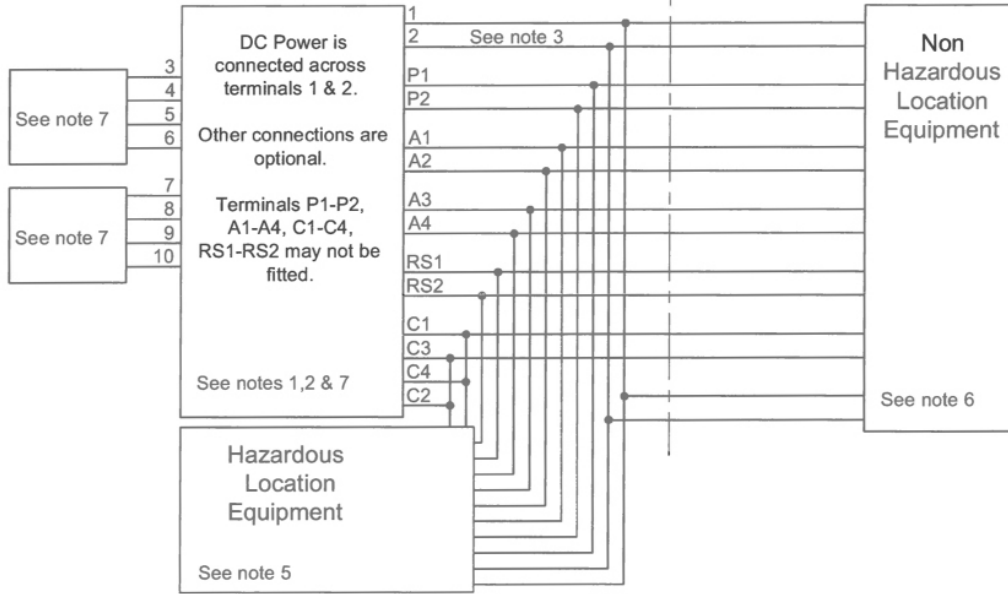

INPUTS IN UNCLASSIFIED LOCATION

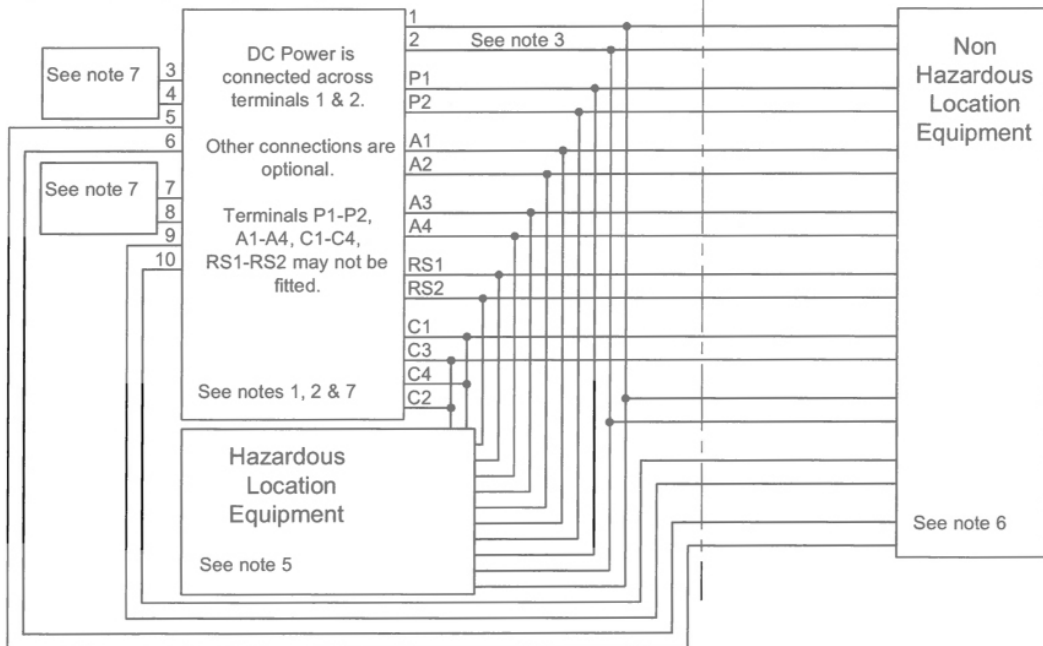

Title
ETL Nonincendive
Control Drawing for 'E' and 'G' series
externally powered rate totalisers.

Drawn SQ
Checked OL
Scale -

Drawing No. **CI330-53**
Sheet 1 of 6

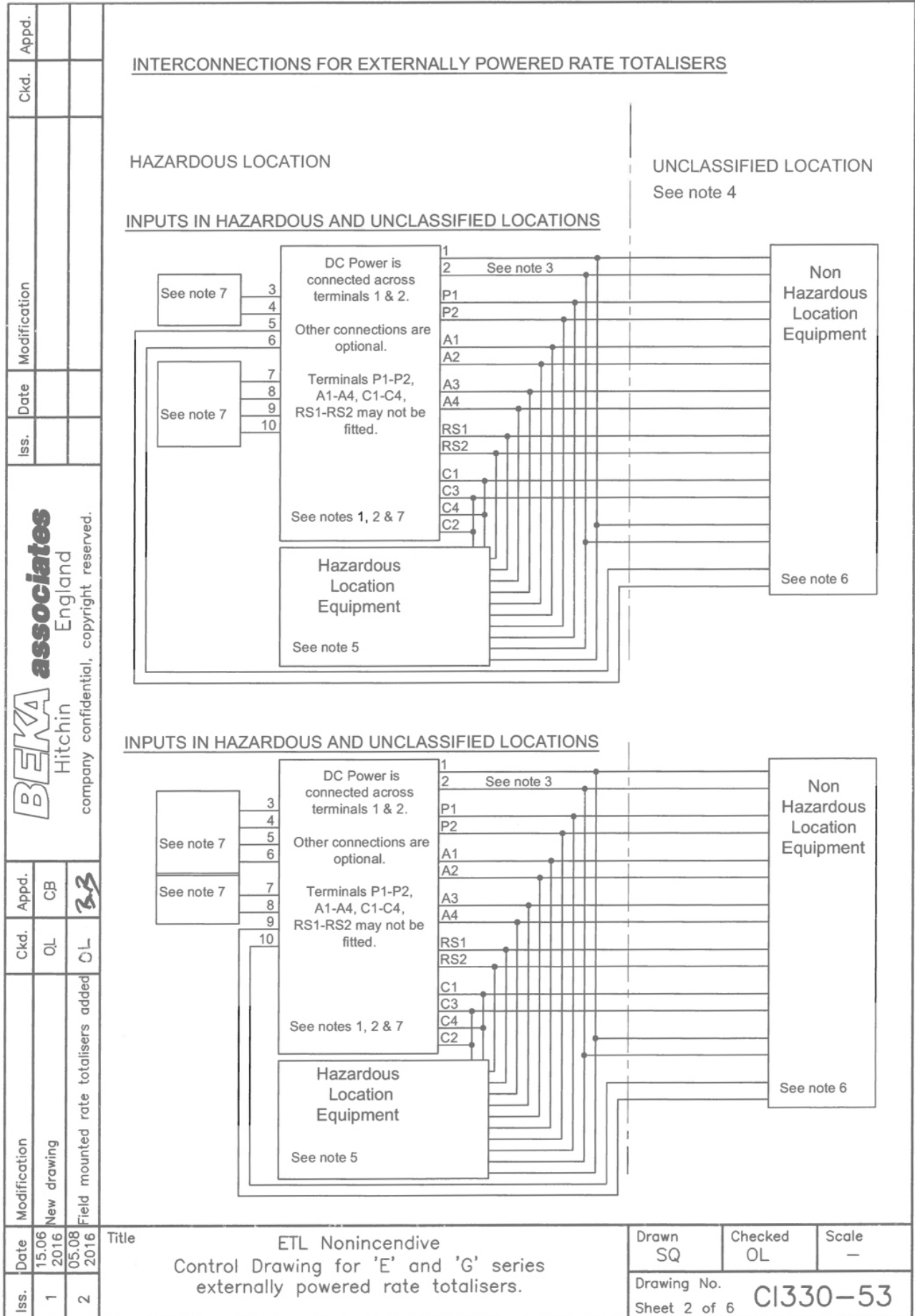

HAZARDOUS LOCATION

UNCLASSIFIED LOCATION
See note 4

HAZARDOUS LOCATION

UNCLASSIFIED LOCATION
See note 4

BEKA associates
 Hitchin
 England
 company confidential, copyright reserved.

Iss.		Date		Modification		Ckd.		Appd.		
1		15.06 2016		New drawing		OL		CB		
2		05.08 2016		Field mounted rate totalisers added		OL		B.B		
										
<p>2. Terminals 7, 8, 9 and 10 only exist on 2 input instruments.</p> <p>3. Nonincendive field wiring installations shall be in accordance with the National Electrical Code ANSI/NFPA 70. The Nonincendive Field Wiring concept allows interconnection of Nonincendive Field Apparatus with Associated Nonincendive Field Wiring Apparatus using any of the wiring methods permitted for unclassified locations. Installations in Canada shall be in accordance with the Canadian Electrical Code C22.2.</p> <p>4. Classified location equipment shall be NRTL Approved Nonincendive Field Wiring Apparatus or simple apparatus as defined in ANSI/NFPA70. For Canadian installations classified location equipment shall be NRTL or CSA Approved Nonincendive Field Wiring Apparatus.</p> <p>5. Simple Apparatus as defined in the National Electrical Code ANSI/NFPA 70, 3r for installations in Canada by the Canadian Electrical Code C22.2 or as defined in note 2.</p> <p>6. The unclassified location equipment shall not use or generate more than 250V rms or 250V dc.</p>										
Title				ETL Nonincendive Control Drawing for 'E' and 'G' series externally powered rate totalisers.			Drawn SQ		Checked OL	
							Scale -			
							Drawing No. Sheet 4 of 6		C1330-53	

Iss.	Date	Modification	Ckd.	Appd.		
1	15.06 2016	New drawing	OL	CB		
2	05.08 2016	Field mounted rate totalisers added	OL	AB		
 BEKA associates Hitchin England company confidential, copyright reserved.						
<p>7. Safety parameters</p> <table border="0" style="width: 100%;"> <tr> <td style="width: 50%; vertical-align: top;"> <p>DC Power terminals 1 & 2</p> <p>$U_i = 30V$ $I_i = 100mA$</p> <p>Terminals 4,5,6 (input A for models in notes 5 and 6), terminals 8,9,10 (input b for models in note 6).</p> <p>$U_i = 30V$ $U_o = 1.1V$ $I_o = 0.5mA$</p> <p>Optional pulse output terminals P1 & P2</p> <p>$U_i = 30V$ $I_i = 100mA$ $U_o = 0$ $I_o = 0$</p> <p>Optional alarm output terminals A1, A2, A3 and A4</p> <p>$U_i = 30V$ $I_i = 200mA$ $U_o = 1.47V$ $I_o = 1\mu A$</p> </td> <td style="width: 50%; vertical-align: top;"> <p>Terminals RS1-RS2, (optional reset input)</p> <p>$U_i = 30V$ $U_o = 3.8V$ $I_o = 1mA$</p> <p>Terminal 3,4,5,6 (for models in notes 5 and 6), terminals 7,8,9,10 (input b with terminals for models in note 6).</p> <p>$U_i = 15V$ $U_o = 10.5V$ $I_o = 9.2mA$</p> <p>Optional 4-20mA output terminals C1, C2, C3 and C4</p> <p>$U_i = 30V$ $U_o = 0$ $I_o = 0$</p> </td> </tr> </table>					<p>DC Power terminals 1 & 2</p> <p>$U_i = 30V$ $I_i = 100mA$</p> <p>Terminals 4,5,6 (input A for models in notes 5 and 6), terminals 8,9,10 (input b for models in note 6).</p> <p>$U_i = 30V$ $U_o = 1.1V$ $I_o = 0.5mA$</p> <p>Optional pulse output terminals P1 & P2</p> <p>$U_i = 30V$ $I_i = 100mA$ $U_o = 0$ $I_o = 0$</p> <p>Optional alarm output terminals A1, A2, A3 and A4</p> <p>$U_i = 30V$ $I_i = 200mA$ $U_o = 1.47V$ $I_o = 1\mu A$</p>	<p>Terminals RS1-RS2, (optional reset input)</p> <p>$U_i = 30V$ $U_o = 3.8V$ $I_o = 1mA$</p> <p>Terminal 3,4,5,6 (for models in notes 5 and 6), terminals 7,8,9,10 (input b with terminals for models in note 6).</p> <p>$U_i = 15V$ $U_o = 10.5V$ $I_o = 9.2mA$</p> <p>Optional 4-20mA output terminals C1, C2, C3 and C4</p> <p>$U_i = 30V$ $U_o = 0$ $I_o = 0$</p>
<p>DC Power terminals 1 & 2</p> <p>$U_i = 30V$ $I_i = 100mA$</p> <p>Terminals 4,5,6 (input A for models in notes 5 and 6), terminals 8,9,10 (input b for models in note 6).</p> <p>$U_i = 30V$ $U_o = 1.1V$ $I_o = 0.5mA$</p> <p>Optional pulse output terminals P1 & P2</p> <p>$U_i = 30V$ $I_i = 100mA$ $U_o = 0$ $I_o = 0$</p> <p>Optional alarm output terminals A1, A2, A3 and A4</p> <p>$U_i = 30V$ $I_i = 200mA$ $U_o = 1.47V$ $I_o = 1\mu A$</p>	<p>Terminals RS1-RS2, (optional reset input)</p> <p>$U_i = 30V$ $U_o = 3.8V$ $I_o = 1mA$</p> <p>Terminal 3,4,5,6 (for models in notes 5 and 6), terminals 7,8,9,10 (input b with terminals for models in note 6).</p> <p>$U_i = 15V$ $U_o = 10.5V$ $I_o = 9.2mA$</p> <p>Optional 4-20mA output terminals C1, C2, C3 and C4</p> <p>$U_i = 30V$ $U_o = 0$ $I_o = 0$</p>					
<p>8. The 'AEx ic' in codes refers to instrument push button contacts which are nonincendive.</p>						
<p>9. When installed purely as non-incendive equipment, the ambient temperature range of the BA317NE, BA337NE, BA367NE, BA377NE, BA314NG, BA334NG, BA364NG, BA374NG, and BA384NG is: $-40^{\circ}C \leq T_a \leq +70^{\circ}C$.</p>						
<p>Date</p> <p>15.06 2016</p>			<p>Title</p> <p style="text-align: center;">ETL Nonincendive Control Drawing for 'E' and 'G' series externally powered rate totalisers.</p>			
<p>Drawn</p> <p>SQ</p>			<p>Checked</p> <p>OL</p>			
<p>Scale</p> <p>—</p>			<p>Drawing No.</p> <p style="text-align: right; font-size: 1.2em;">C1330-53</p>			
<p>Sheet 5 of 6</p>			<p>File No 330-53s05.dwg 05.08.16</p>			

Iss.	1	Date	15.06 2016	Modification	New drawing	Ckd.	OL	Appd.	CB
Iss.	2	Date	05.08 2016	Modification	Field mounted rate totalisers added	Ckd.	OL	Appd.	B.B
<p>BEKA associates Hitchin England company confidential, copyright reserved.</p>									
<p>10. CAUTION The BA317E, BA318E, BA337E, BA338E, BA367E, BA368E, BA377E, BA378E and the BA388E Externally Powered rate totaliser enclosures may carry the following potential electrostatic warning:</p> <p style="text-align: center;">WARNING Potential electrostatic charging hazard clean only with a damp cloth</p> <p style="text-align: center;">AVERTISSEMENT Risque potentiel de charge électrostatique Nettoyer uniquement avec un chiffon humide</p> <p>Alternatively, the enclosures may be manufactured from a conducting plastic per Article 250 of the National Electrical Code.</p>									
<p>11. When mounting the BA317E, BA318E, BA337E, BA338E, BA367E, BA368E, BA377E, BA378E, BA388E, BA317E-SS, BA337E-SS, BA367E-SS, BA377E-SS, BA317NE, BA337NE, BA367NE & BA377NE panel mounting Externally Powered Rate Totalisers in an enclosure to maintain Type 4 front panel rating:</p> <p style="text-align: center;">Minimum panel thickness should be 2mm (0.08inches) Steel 3mm (0.12inches) Aluminium</p> <p>Outside panel finish should be smooth, free from particles, inclusions, runs or build-ups around cut-out.</p> <p>Panel cut-out for BA317E, BA337E, BA367E, and BA377E shall be: 90.0 x 43.5mm -0.0 +0.5mm (3.54 x 1.71 inches -0.00 +0.02)</p> <p>Two panel mounting clips are required for BA317E, BA337E, BA367E, and BA377E and each shall be tightened to between: 20 & 22cNm (1.77 to 1.95inLb)</p> <p>Panel cut-out for BA318E, BA338E, BA368E, BA378E, and BA388E shall be: 136.0 x 66.2mm -0.0 +0.5mm (5.35 x 2.60 inches -0.00 +0.02)</p> <p>Four panel mounting clips are required for BA318E, BA338E, BA368E, BA378E, and BA388E and each shall be tightened to between: 20 & 22cNm (1.77 to 1.95inLb)</p> <p>Panel cut-out for BA317E-SS, BA337E-SS, BA367E-SS, BA377E-SS, BA317NE, BA337NE, BA367NE & BA377NE shall be: (92.0mm -0.0 +0.8) x (45.0mm -0.0 +0.6) (3.62 inches -0.00 +0.03) x (1.77 inches - 0.00 +0.02)</p> <p>Four panel mounting clips are required for BA317E-SS, BA337E-SS, BA367E-SS, BA377E-SS, BA317NE, BA337NE, BA367NE & BA377NE and each shall be tightened to at least: 22cNm (1.95inLb)</p>									
Title						Drawn	Checked	Scale	
ETL Nonincendive Control Drawing for 'E' and 'G' series externally powered rate totalisers.						SQ	OL	-	
						Drawing No.		CI330-53	
						Sheet 6 of 6			